

## Presentation of the Smith-Purcell Experiment at SOLEIL

N. Delerue, J. Barros, S. Jenzer, M. Vieille Grosjean, L. Cassinari, M. Labat,  
G. Doucas, I.V. Konoplev, A. Reichold, A. Faus-Golfe, et al.

► **To cite this version:**

N. Delerue, J. Barros, S. Jenzer, M. Vieille Grosjean, L. Cassinari, et al.. Presentation of the Smith-Purcell Experiment at SOLEIL. IBIC2013 - 2nd International Beam Instrumentation Conference, Sep 2013, Oxford, United Kingdom. Joint Accelerator Conferences Website, TUPC37, pp.460-463, 2013. in2p3-00862652

**HAL Id: in2p3-00862652**

**<http://hal.in2p3.fr/in2p3-00862652>**

Submitted on 20 Sep 2013

**HAL** is a multi-disciplinary open access archive for the deposit and dissemination of scientific research documents, whether they are published or not. The documents may come from teaching and research institutions in France or abroad, or from public or private research centers.

L'archive ouverte pluridisciplinaire **HAL**, est destinée au dépôt et à la diffusion de documents scientifiques de niveau recherche, publiés ou non, émanant des établissements d'enseignement et de recherche français ou étrangers, des laboratoires publics ou privés.

# PRESENTATION OF THE SMITH-PURCELL EXPERIMENT AT SOLEIL\*

N. Delerue<sup>†</sup>, J. Barros, S. Jenzer, M. Vieille Grosjean, LAL, Orsay, France  
A. Faus-Golfe, N. Fuster Martinez, J. Resta-López, IFIC, Valencia, Spain  
G. Doucas, I. Konoplev, A. Reichold, JAI, Oxford, UK  
M. Labat, L. Cassinari, Synchrotron SOLEIL, Gif Sur Yvette, France

## Abstract

The potential of Coherent Smith-Purcell radiation as a longitudinal bunch profile monitor has already been demonstrated and has recently been extended to the sub-picosecond range. As a critical step toward the construction of a single shot bunch profile monitor using Coherent Smith-Purcell radiation it is important to measure very accurately the distribution of such radiation. Optimum background suppression techniques need to be found and relatively cheap detectors suitable for the far infra-red need to be qualified. To perform these tasks a test stand has been installed at the end of the linac of the synchrotron SOLEIL. This test stand and the first results from its commissioning will be presented here.

## INTRODUCTION: COHERENT SMITH-PURCELL RADIATION

The potential use of Coherent Smith-Purcell radiation (CSPR) as a beam longitudinal profile monitor has been discussed in several publications [1, 2, 3]. Like most coherent radiative phenomena at accelerators, the CSPR encodes the longitudinal form factor of the particle bunch in its wavelength distribution. CSPR is generated by approaching the beam with a diffraction grating. This has the advantage of spreading the radiation emitted in different directions depending on its wavelength, allowing an easier rejection of the background noise coming from other sources (see Figure 1). Several theories have been proposed to describe CSPR [4, 5] and some comparisons have been done at low energy [6]. However to use CSPR as a single shot longitudinal profile monitor an accurate and experimentally validated description of the distribution of the radiation is necessary. The aim of SPESO (Smith-Purcell Experiment at SOLEIL) is to perform such measurement.

## SPESO: LAYOUT

SPESO is installed at the end of the SOLEIL linac. At this location the electrons have an energy of 100 MeV and during normal operations of SOLEIL trains of bunches pass there every 2-3 minutes. The setup is designed so that it does not affect the electrons injected in the synchrotron and

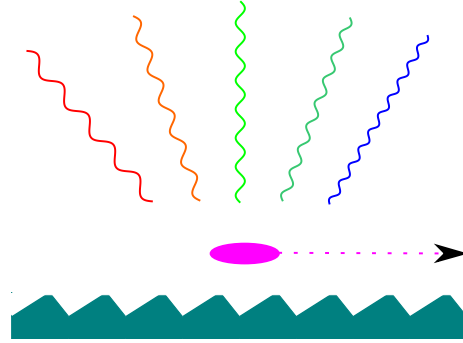

Figure 1: Smith-Purcell radiation is emitted when an electron beam passes near a grating.

therefore data can be taken during normal synchrotron user operations.

The layout of SPESO is shown on Figure 2. We use a  $40\text{mm} \times 20\text{mm}$  diffraction grating with grooves spaced by  $1.5\text{mm}$  blazed at  $30^\circ$  made of aluminum. The diffraction grating is mounted on an in-vacuum linear actuator supplied by UHV design. This actuator can travel between two chambers separated by a vacuum valve. When the actuator is retracted, the grating is in the “antechamber” and the vacuum valve can be closed. This allows to change the grating without breaking the vacuum of the linac. When the valve is opened the grating can be moved to the main chamber where it can be approached to the electron beam.

A large ( $210\text{mm} \times 86\text{mm}$ ) z-cut crystal quartz window supplied by Crystran is installed opposite to the grating to allow the radiation to exit the accelerator vacuum. Outside the vacuum several detectors mounted on a translation stage are installed. In the final configuration these translation stages will allow to move 2 sets of detectors along 5 axes (3 translations and 2 rotations), allowing to map the intensity of the radiation as a function of the position of the detectors along these axis. A picture of the setup in its present configuration is shown on Figure 3.

It is foreseen that toward the end of this year the single grating will be replaced by a set of up to 8 gratings mounted on a carousel, allowing comparison between different gratings (different materials, different blaze angle, different pitch,...) without requiring an access to the linac at each configuration change.

\* Work supported by the IN2P3, the Université Paris-Sud (programme “attractivité”) and the French ANR (contract ANR-12-JS05-0003-01).

<sup>†</sup> delerue@lal.in2p3.fr

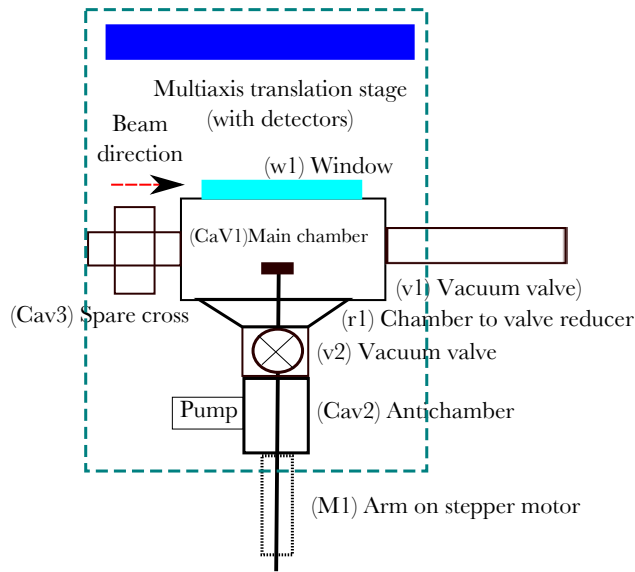

Figure 2: The experimental setup of SPESO at the end of the SOLEIL Linac.

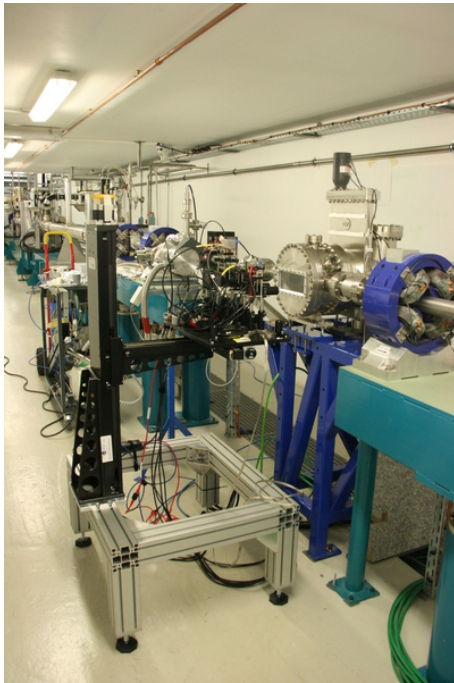

Figure 3: The experimental setup of SPESO at the end of the SOLEIL Linac.

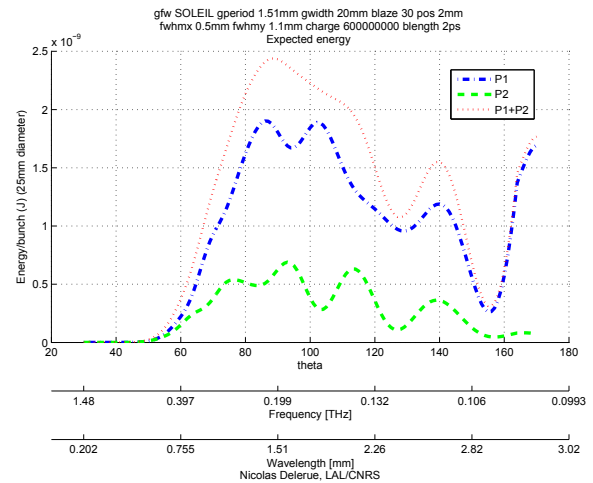

Figure 4: Simulations of the signal expected by SPESO for a 2ps long bunch with a 1.5mm grating at 100 MeV. The red line gives the total intensity of the signal expected. The blue and green curves give the signal expected for the two polarization components.

## PREDICTED YIELD

Simulations have been performed using a dedicated software based on [4] to estimate the expected signal intensity and distribution. Some of these simulations are shown on Figure 4.

## FAR INFRARED DETECTORS

In the SOLEIL linac the length of the electron bunches is expected to be of the order of a few millimeters. The wavelength of the CSPR is therefore expected to be in the same range. The only far infrared broadband detectors available in that wavelength range are either pyroelectric detectors or bolometers. Although bolometers have a much better sensitivity they require regular liquid helium refilling which is not possible at our location hence we use pyroelectric detectors. We have tested detectors from several suppliers and with different type of amplification. Prior to installing the detectors in the linac we measured their relative sensitivity

by installing the detectors in front of a blackbody radiation source on a translation stage and measuring the signal at attenuation as we increased the separation (see Figure 5).

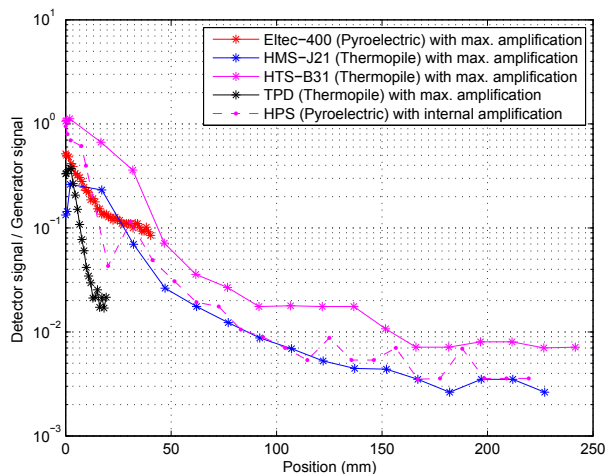

Figure 5: Study of the sensitivity of different pyroelectric detectors. The sensitivity is measured by increasing the distance between an infra-red source and the detector.

As the expected signal yield at SOLEIL is rather low, the signal will have to be amplified significantly. Different amplification strategies using either FET or operational amplifiers are currently under considerations.

## RECENT RESULTS

SPESO has been installed during the April 2013 shutdown of SOLEIL. The first step of the commissioning was to check that there were no radioprotection issues. This was done by inserting the grating slowly into the beam and checking that the radiation detectors outside the accelerator tunnel did not detect any increase in radiation. Once these tests had confirmed that no radiation had been observed outside, further tests were done to find the closest position at which the grating did not affect the beam injected in the booster, allowing the operation of the experiment to be compatible with user mode.

These tests were also an opportunity to test the signal measured at close range. An example of signal observed as the grating was approaching the beam is shown on Figure 6. During a subsequent shift we studied the signal observed and confirmed that its intensity is correlated with the position of the grating (Figure 7).

## OUTLOOK

The Smith-Purcell Experiment at SOLEIL is still in its commissioning phase. The signal observed so far has been with high charge beam and we now need to confirm that we can also see signal with the nominal beam charge used during users operations. Once this will have been done we will use the multi-axis actuator to measure the signal distribution in several directions.

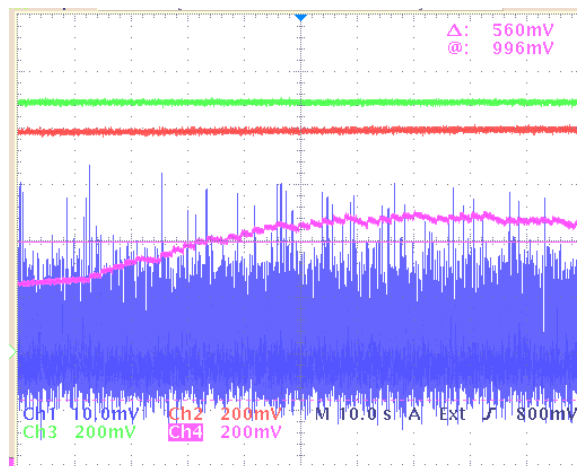

Figure 6: Magenta line: signal observed when the grating approaches the beam; the other lines correspond to other detectors not in front of the window.

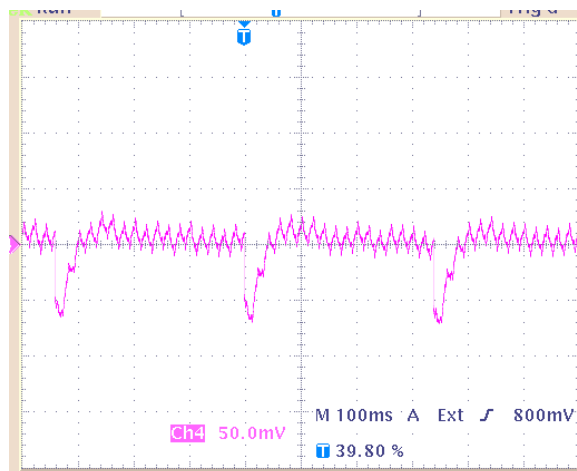

Figure 7: Magenta line: 3 Hz signal observed when the grating is inserted.

## ACKNOWLEDGMENT

The financial support of the Université Paris-Sud (programme “attractivité”) and the French ANR (contract ANR-12-JS05-0003-01) are gratefully acknowledged.

## REFERENCES

- [1] G. Doucas, et al., “Longitudinal electron bunch profile diagnostics at 45-MeV using coherent Smith-Purcell radiation”, *Phys. Rev. ST Accel. Beams* 9 (2006) 092801.
- [2] V. Blackmore, G. Doucas, C. Perry, et al., “First measurements of the longitudinal bunch profile of a 28.5 gev beam using coherent smith-purcell radiation”, *Phys. Rev. ST Accel. Beams* 12 (2009) 032803. doi:10.1103/PhysRevSTAB.12.032803. <http://link.aps.org/doi/10.1103/PhysRevSTAB.12.032803>
- [3] R. Bartolini, C. Clarke, N. Delerue, et al., “Electron bunch profile reconstruction in the few fs regime using coherent

Smith-Purcell radiation”, Journal of Instrumentation 7 (01) (2012) P01009.

<http://stacks.iop.org/1748-0221/7/i=01/a=P01009>

- [4] J. H. Brownell, J. Walsh, G. Doucas, “Spontaneous smith-purcell radiation described through induced surface currents”, Phys. Rev. E 57 (1998) 10751080. doi:10.1103/PhysRevE.57.1075.

<http://link.aps.org/doi/10.1103/PhysRevE.57.1075>

- [5] A. S. Kesar, “Smith-purcell radiation from a charge moving above a grating of finite length and width”, Phys. Rev. ST Accel. Beams 13 (2010) 022804. doi:10.1103/PhysRevSTAB.13.022804.

<http://link.aps.org/doi/10.1103/PhysRevSTAB.13.022804>

- [6] D. V. Karlovets, A. P. Potylitsyn, “Comparison of smith-purcell radiation models and criteria for their verification”, Phys. Rev. ST Accel. Beams 9 (2006) 080701. doi:10.1103/PhysRevSTAB.9.080701.

<http://link.aps.org/doi/10.1103/PhysRevSTAB.9.080701>