

The vacuum system of the GANIL beam lines

C. Ricaud, G. Rommel

► **To cite this version:**

C. Ricaud, G. Rommel. The vacuum system of the GANIL beam lines. F. Marti. Tenth International Conference on Cyclotrons and their Applications, Apr 1984, East Lansing, United States. IEEE, pp.147-149, 1984. <in2p3-00996420>

HAL Id: in2p3-00996420

<http://hal.in2p3.fr/in2p3-00996420>

Submitted on 24 May 2017

HAL is a multi-disciplinary open access archive for the deposit and dissemination of scientific research documents, whether they are published or not. The documents may come from teaching and research institutions in France or abroad, or from public or private research centers.

L'archive ouverte pluridisciplinaire **HAL**, est destinée au dépôt et à la diffusion de documents scientifiques de niveau recherche, publiés ou non, émanant des établissements d'enseignement et de recherche français ou étrangers, des laboratoires publics ou privés.

GANIL

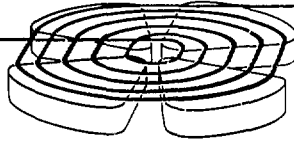

THE VACUUM SYSTEM OF THE GANIL BEAM LINES

C. RICAUD, G. ROMMEL
GRAND ACCELERATEUR NATIONAL D'IONS LOURDS
BP 5027 14021 CAEN CEDEX (FRANCE)

GANIL. A84.06

THE VACUUM SYSTEM OF THE GANIL BEAM LINES

C. RICAUD, G. ROMMEL

GRAND ACCELERATEUR NATIONAL D'IONS LOURDES
BP 5027 14021 CAEN CEDEX (France)

ABSTRACT

The GANIL beam lines are 400 m. long and the average diameter of the pipes is 60 mm. Every fifth meter a beam diagnostic with a high desorption rate is installed. A pressure lower than 10^{-5} Pascal is required. The method of vacuum calculation, the reasons for the choice of our pumps (turbo molecular and cryogenic) and the results are given.

Lines	Ion	W_{Mc}	ρ_{pa}	$L_m(a)$
L 1	U^{6+}	0.0156	1×10^{-5}	38
L 2	U^{6+}	0.25	1×10^{-4}	14
L'2	U^{24+}	0.25	3×10^{-5}	24
L 3	U^{24+}	4.	8×10^{-5}	48
L 4	U^{24+}	4.	5×10^{-5}	70

- Table 1 -

The GANIL accelerator is composed of three cyclotrons in cascade. The beam is transported from a cyclotron to the next one and to the Experimental Areas through different lines.

In order to achieve a maximum transmission efficiency, pressure in the lines has to be low enough. The pressure value is dependent on the Ion type, on its charge state and energy. Hence the pressure is not the same all along the lines.

So we tried to realize pumping in the lines at the lowest cost taking care of staying below the pressure limits.

1. BRIEF DESCRIPTION AND PRESSURE VALUES

The total length of the beam lines (see Fig. 1) is 400 m. Table 1 gives for each beam-line the average pressure required to reach a 95 % transmission for Uranium¹, the heaviest Ion at the lowest energy that GANIL is able to accelerate.

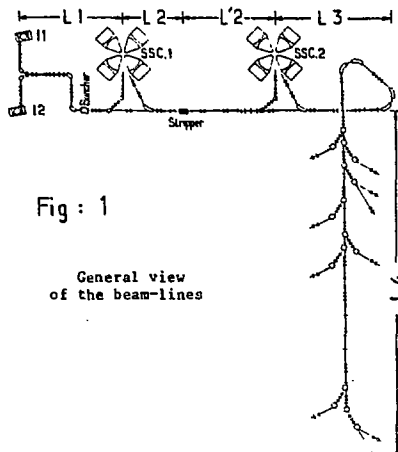

Fig : 1

General view
of the beam-lines

(a) Beam pathlength.

2. IMPOSED CONDITIONS

At the beginning of the project and in order to obtain the desired performances, we had to fulfill the following conditions :

- No diffusion Pump within 20 m. of the SSC and of all apparatus including high voltage elements, in order to eliminate every oil contamination risk.
- Use only metallic seals and membranes.
- Eliminate rotating or linear shaft feedthroughs.
- Minimize the number of Pump types.
- Obtain the required pressure 50 hours after the beginning of the pumping starting at the atmospheric pressure.
- Divide the beam-lines in sections separated by valves in order to work at atmospheric pressure (when necessary) on limited portions only.

3. EQUIPMENTS USED IN THE BEAM-LINES

The pipe is made of stainless steel (304 L or 316 L) chemically cleaned and does not present any particular problem for the vacuum. On the other hand the different diagnostics necessary to control the beam have a high desorption flux. All along the lines there are : 100 profile monitors, 7 Faraday cups, 27 slits, 8 central phase monitors, 3 phase extension ones and 20 beam stops.

The beam profile monitors made us very anxious because of their technology. The different materials constituting such a monitor are shown on Fig. 2. The desorption rate of the different monitors is given on Fig. 3.

It can be verified that even when choosing the materials carefully the beam profile monitor presents a desorption rate from three to ten times higher than the other diagnostics. This involves a supplementary condition for placing the pumps. In fact if a pump is placed one meter from a beam profile monitor and if the tube diameter is 72 mm. the drop of pressure for

a one meter long tube is : $\Delta P = 2.5 \times 10^{-5}$ Pa after 50 hours. Hence, except for the LJ line, this ΔP exceeds the required mean pressure. So a pump must be placed very close to each beam profile monitor.

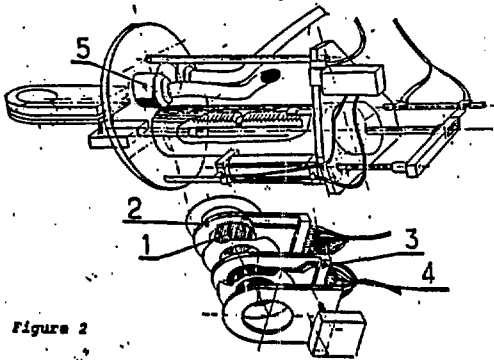

Figure 2

1. Golden tungsten captor wires diameter 20 μ m, 30 g tightened.
2. Teklon + glass (DIXLAD) printed circuit supports.
3. Alumina printed circuit connectors.
4. Connexion wires insulated with irradiated Teflon (TEFZEL).
5. Feedthrough connectors with 52 stainless steel pins embedded in glass and mounted on a Covar-stainless steel flange.

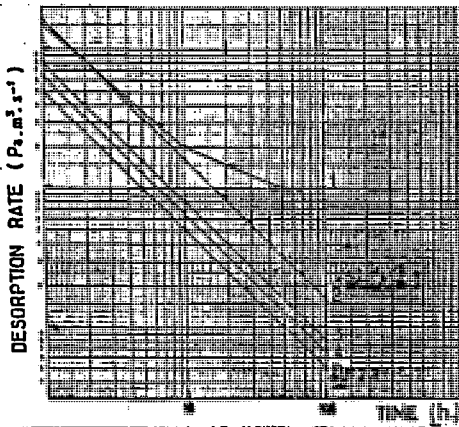

Figure 3

- 0 - 1m7 stainless-steel
 1 - Profile monitor
 2 - Slit
 3 - Faraday cup
 Phase central monitor
 Phase extension monitor
 4 - Beam stop

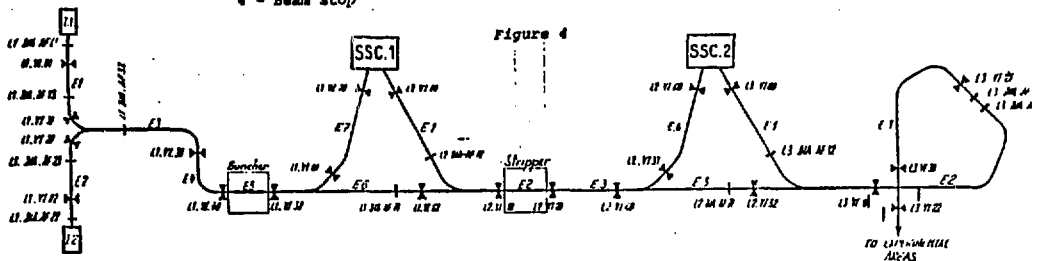

Figure 4

4. VACUUM PUMPING SYSTEM

4.1. Vacuum pumping rate calculations

The accelerator has three beam lines L1, L2 and L which are divided in sections named E1, E2, E3... for each line (see Fig. 4). For example ², we make these calculations on the L1E1 section which is located between the injector exit and the first vacuum valve. The position of each equipment can be seen on Figure 5

The pump 1 absorbs the sum of the gas flux ($\Sigma \Phi$) desorbed by the pipe between the injector I1 and the point A (half distance between the two wire detectors) the Faraday cup and the wire detector.

The pressure P_0 above the pump is equal to $\Sigma \Phi / S$ (S is the real pumping rate of the pump).

The average pressure between the pump 1 and the point A is :

$$P_{av} = P_0 + \frac{\Phi}{3C}$$

Φ gas flux desorbed by the pipe in $\text{Pa. m}^3 \cdot \text{s}^{-1}$
 C pipe conductance between the pump 1 and A.

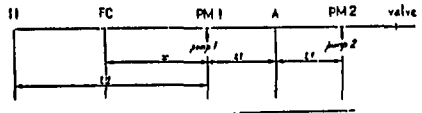

FC : Faraday Cup
 PM : Profile Monitor

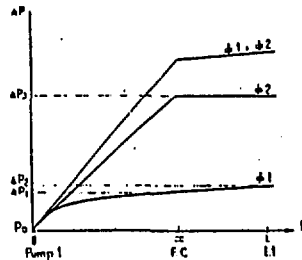

$\Phi 1$: distributed desorption
 $\Phi 2$: localized desorption.

Figure 5

The conductance between I1 and the beam-line is very low, so the I1 pumping system does not contribute to the line vacuum. Then two phenomena act together : the distributed desorption and the localized one. The last one gives a linear pressure distribution (see Fig. 5). The average pressure between pump 1 and FC, and the one between FC and I1 have to be separate. So the average pressure between I1 and A is given by :

$$P_{av} = \frac{\sum P_{av} \cdot l_i}{\sum l_i}$$

where P_{av} : average pressure of each part
and l_i : length of each part

$$P_{av}(I1, A) = \frac{P_{av}(l_1) \cdot l_1 + P_{av}(x) \cdot x + P_{av}(l_2-x) \cdot (l_2-x)}{l_1 + l_2}$$

4.2. Pumps choice

Considering the results of the calculation, we selected some 400 1/s turbomolecular pumps and 500 or 1500 1/s CRYOGENIC ones, the two last ones being less expensive than the ionic pumps at the date of the choice.

5. RESULTS AND REMARKS

Table 2 compares the required values, the calculated ones, the experimental ones obtained after a 48 hours pumping, starting from atmospheric pressure and the values at the end of the run.

We can observe that :

- we generally obtain some pressures lower than the required ones.
- the pressure at the end of the run is not lower than the pressure after a 48 hour pumping. This is due to the fact that the profile monitors desorption rate is constant after 50 hours.

It should be added that, today in April 84, we never had any transmission problems due to the pressure, but the heaviest accelerated Ion was Kr ($7^+ \rightarrow 26^+$) at 35 MeV/A.

Lines Sections	Pressure (I)			
	Required	Calculated	Measured	
			A(4)	B(5)
L1 E1	1.	0.4	0.88	0.7
L1 E3	1.	0.55	0.78	0.74
L1 E4	1.	0.4	0.1	0.13
L1 E5(2)	1.	0.9	0.24	0.75(6)
L1 E6	1.	0.1	0.4	0.64
L1 E7	1.	1.5	0.3	0.46
L2 E1	10.	2.4	11.	4.6
L2 E2(3)	3.	4.0	0.67	0.51
L2 E3	3.	1.3	0.78	0.51
L2 E5	3.	0.7	0.28	0.13
L2 E6	3.	5.0	0.54	0.64
L3 E1	8.	3.0	3.1	3.8
L3 E2	8.	0.9	1.0	1.5
L3 E3	8.	1.5	0.5	2.0(7)

Table 2

- (1) The pressure is in 10^{-5} Pascal.
- (2) RF - Buncher
- (3) Stripper
- (4) A : after 48 hours, starting at atmospheric pressure
- (5) B : at the end of the run
- (6) With only one cryopump
- (7) With one Turbomolecular pump off.

REFERENCES

1. E. Barou, Calcul des pressions dans les conduites d faisceaux du GANIL. Internal Note, GANIL 76/77, Novembre 1976.
2. C. Tribouillard, Pompage des lignes de transfert. Internal Note, GANIL 79N/126/VI/27 de Juillet 1979.