



**HAL**  
open science

## Report of the GDR working group on the R-parity violation

R. Barbier, C. Bérat, M. Besancon, P. Binetruy, G. Bordes, F. Brochu, Pascal Bruel, F. Charles, C. Charlot, M. Chemtob, et al.

► **To cite this version:**

R. Barbier, C. Bérat, M. Besancon, P. Binetruy, G. Bordes, et al.. Report of the GDR working group on the R-parity violation. [Research Report] CERN, Suisse. 1998. in2p3-00003414

**HAL Id: in2p3-00003414**

**<https://hal.in2p3.fr/in2p3-00003414>**

Submitted on 2 Apr 2021

**HAL** is a multi-disciplinary open access archive for the deposit and dissemination of scientific research documents, whether they are published or not. The documents may come from teaching and research institutions in France or abroad, or from public or private research centers.

L'archive ouverte pluridisciplinaire **HAL**, est destinée au dépôt et à la diffusion de documents scientifiques de niveau recherche, publiés ou non, émanant des établissements d'enseignement et de recherche français ou étrangers, des laboratoires publics ou privés.

# Report of the group on the $R$ -parity violation

R. Barbier<sup>5</sup>, C. Bérat<sup>6</sup>, M. Besançon<sup>12,10</sup>, P. Binetruy<sup>1,10</sup>,  
 G.Bordes<sup>2</sup>, F. Brochu<sup>9</sup>, P. Bruel<sup>8</sup>, F.Charles<sup>14</sup>, C. Charlot<sup>8</sup>,  
 M. Chemtob<sup>13</sup>, P. Coyle<sup>3</sup>, M. David<sup>12</sup>, E. Dudas<sup>1,10</sup>,  
 D. Fouchez<sup>3</sup>, C. Grojean<sup>13</sup>, M. Jacquet<sup>7</sup>, S. Katsanevas<sup>5</sup>, S. Lavignac<sup>4,10,11</sup>,  
 F. Ledroit<sup>6</sup>, R. Lopez<sup>6</sup>, A. Mirea<sup>3</sup>, G. Moreau<sup>13</sup>, C. Mulet-Marquis<sup>6</sup>,  
 E. Nagy<sup>3</sup>, F. Naraghi<sup>6</sup>, R. Nicolaidou<sup>6,12</sup>, P. Paganini<sup>8</sup>, E. Perez<sup>12</sup>,  
 G. Sajot<sup>6</sup>, C.A. Savoy<sup>1,13</sup>, Y. Sirois<sup>8</sup>, C. Vallée<sup>3</sup>

<sup>1</sup> CERN, theory division, CH-1211 Geneva 23, Switzerland

<sup>2</sup> Collège de France, Lab. de Physique Corpusculaire, IN2P3-CNRS; FR-75231, Paris Cedex 05, France

<sup>3</sup> CPPM, Université d'Aix-Marseille 2, IN2P3-CNRS, FR-13288 Marseille Cedex 09, France

<sup>4</sup> Institute for Fundamental Theory, Dept. of Physics, Univ. of Florida, Gainesville FL 32611, USA

<sup>5</sup> IPNL, Université Claude Bernard de Lyon, IN2P3-CNRS, FR-69622 Villeurbanne Cedex, France

<sup>6</sup> Institut des Sciences Nucléaires, IN2P3-CNRS, Université de Grenoble 1, FR-38026 Grenoble Cedex, France

<sup>7</sup> Laboratoire de l'Accélérateur Linéaire, Université de Paris-Sud, IN2P3-CNRS, Bât 200, FR-91405 Orsay Cedex, France

<sup>8</sup> Laboratoire de Physique Nucléaire et des Hautes Energies, Ecole Polytechnique, IN2P3-CNRS, 91128 Palaiseau Cedex, France

<sup>9</sup> Laboratoire de Physique des Particules - LAPP - IN2P3-CNRS, 74019 Annecy-le-Vieux Cedex, France

<sup>10</sup> Laboratoire de Physique Théorique et Hautes Énergies, Université de Paris-Sud, Bât 210, FR-91405 Orsay Cedex, France

<sup>11</sup> Physikalisches Institut, Universität Bonn, Nussallee 12, D-53115 Bonn, Germany

<sup>12</sup> DAPNIA/Service de Physique des Particules, CEA-Saclay, FR-91191 Gif-sur-Yvette Cedex, France

<sup>13</sup> Service de Physique Théorique, CEA-Saclay, FR-91191 Gif-sur-Yvette Cedex, France

<sup>14</sup> Université de Haute Alsace, Mulhouse, France

Contact persons: Marc Besançon (Marc.Besancon@cern.ch)  
 Emilian Dudas (Emilian.Dudas@cern.ch)

# Contents

<b>1</b>	<b>Introduction</b>	<b>4</b>
<b>2</b>	<b>Indirect bounds on <math>R</math>-parity odd interactions</b>	<b>6</b>
2.1	Bilinear interactions and spontaneously broken $R$ -parity	7
2.2	Trilinear interactions	7
2.2.1	Four-fermions contact interactions	8
2.2.2	Charged current interactions	9
2.2.3	Neutral current interactions	10
2.3	Scattering and decay processes	11
2.3.1	Lepton flavour violation ( $\delta L = 0$ )	11
2.3.2	Lepton number violation, ( $ \delta L  > 0$ )	12
2.3.3	Hadrons flavour violation	12
2.3.4	Baryon number violation	13
2.4	Conclusions	15
<b>3</b>	<b>Alternatives to conserved <math>R</math>-parity</b>	<b>17</b>
<b>4</b>	<b>Single production of supersymmetric particles</b>	<b>21</b>
4.1	Indirect effects	21
4.2	Single production	21
4.2.1	Resonant production at LEP	21
4.2.2	Resonant production at Tevatron and LHC	22
4.3	Systematic study of single production	22
<b>5</b>	<b>On the discovery potential of HERA for <math>R</math>-parity violating SUSY</b>	<b>24</b>
5.1	Introduction	24
5.2	Phenomenology	24
5.3	Results from HERA	27
5.4	Constraints and Discovery Potential	30
<b>6</b>	<b>Do we need conserved <math>R</math>-parity at LEP?</b>	<b>32</b>
6.1	Effects of the $R$ -parity violating couplings in the decay	32
6.2	Effects of the $R$ -parity violating couplings in the single production	39
6.3	Indirect effects of the $R$ -parity $\lambda'$ violating couplings in $e^+e^-$ colliders	39
6.4	$R$ -parity scenario at LEP2, at $\sqrt{s} = 200$ GeV, with a high luminosity	39
6.4.1	Pair production of gauginos	40
6.4.2	Hypothesis on the $R$ -parity violating couplings	40
6.4.3	Direct and indirect decays of gauginos	41
6.4.4	Expected limits at $\sqrt{s} = 200$ GeV	41
6.5	Conclusion	43
<b>7</b>	<b><math>R</math>-parity violation at LHC</b>	<b>44</b>
7.1	ATLAS discovery potential	45
7.2	CMS discovery potential	47
7.2.1	SUSY signal simulation	47
7.2.2	SM background simulation	48
7.2.3	CMS detector simulation	48
7.2.4	Events selection	48
7.2.5	Results and conclusion	48
<b>8</b>	<b>Neutrino masses and <math>R</math>-parity violation</b>	<b>50</b>
<b>9</b>	<b>Conclusions and perspectives</b>	<b>53</b>
<b>10</b>	<b>Appendix A</b>	<b>54</b>



# 1 Introduction

It is a well-known fact that the conservation of the baryon and lepton number is an automatic consequence of the gauge invariance and renormalizability in the Standard Model. Their non-conservation is generally considered in the context of grand unified theories. In this case, their effects (like proton decay, for example) are suppressed by powers of the grand unified scale, which is supposed to be of the order of  $2 \times 10^{16} GeV$ . Therefore these effects are difficult to observe experimentally.

In supersymmetric extensions of the Standard Model, gauge invariance and renormalizability no longer assures baryon and lepton number conservation. We will consider in what follows the MSSM as the minimal supersymmetric extension, but the following considerations are easy to generalize. By renormalizability and gauge invariance, we can write two different types of Yukawa-type interactions, described by a superpotential  $W = W_1 + W_2$ , where

$$W_1 = \mu(H_u H_d) + (\lambda_u)_{ij}(Q_i H_u)D_j^c + (\lambda_d)_{ij}(Q_i H_d)D_j^c + (\lambda_e)_{ij}(L_i H_d)E_j^c \quad (1)$$

and

$$W_2 = \mu(H_u L_i) + \lambda_{ijk}(L_i L_j)E_k^c + \lambda'_{ijk}(Q_i L_j)D_k^c + \lambda''_{ijk}(U_i^c D_j^c D_k^c), \quad (2)$$

where we have exhibited the dependence on the quarks and lepton family indices,  $i, j, \dots$  and the parentheses enclosing fields products are meant to remind that one is to take overall singlet contractions with respect to the  $SU(3)_c \times SU(2)_L$  gauge group indices. The superpotential  $W_1$  contains the usual Yukawa interactions of the quarks and leptons and, in addition, the Higgs supersymmetric mass term  $\mu$ . The usual gauge interactions supplemented by  $W_1$  give a theory where the baryon and the lepton numbers are automatically conserved.

On the other hand, even if renormalizable and gauge invariant, the terms in  $W_2$ <sup>1</sup>

do violate the baryon ( $B$  by the 9  $\lambda''_{ijk}$  couplings) and the lepton number ( $L$  by the 9  $\lambda_{ijk}$  couplings and the 27  $\lambda'_{ijk}$  couplings) and they are not suppressed by any large mass scale. They may for example induce proton decay through product of couplings  $\lambda' \times \lambda''$  and, if these couplings are of order one, this is certainly unacceptable. Different combinations of couplings induce different baryon and lepton non-conserving transitions and, as we will see in detail in the next sections, are severely constrained experimentally. That's why, in 1978 Farrar and Fayet [1] proposed a discrete symmetry  $R$  such that  $RW_1 = W_1$  and  $RW_2 = -W_2$  and therefore automatically guarantees the  $B$  and  $L$  conservation.

This symmetry, called R-parity, acts as 1 on all known particles and as  $-1$  on all the superpartners and can be written

$$R = (-1)^{3B+L+2S}, \quad (3)$$

where  $S$  is the spin of the particle. The physics of the MSSM with a conserved R-parity is very peculiar, since the lightest supersymmetric particle (LSP) cannot desintegrate into ordinary particles and is therefore stable. In this case, the superpartners can be produced only in pairs and their direct search must typically wait for high energy colliders, LHC or NLC.

On the other hand, even if rather elegant, the ad-hoc imposition of the R-parity is not theoretically very-well motivated and neither sufficient for suppressing all the dangerous  $B$  and  $L$  violating terms. For example, if we consider MSSM as an effective theory, which is certainly the case and search for gauge-invariant higher-dimension operators, we can immediately write down the terms

$$\begin{aligned} W_3 = & \frac{(\kappa_1)_{ijkl}}{\Lambda}(Q_i Q_j)(Q_k L_l) + \frac{(\kappa_2)_{ijkl}}{\Lambda}(U_i^c U_j^c D_k^c)E_l^c + \frac{(\kappa_3)_{ijk}}{\Lambda}(Q_i Q_j)(Q_k H_d) + \\ & + \frac{(\kappa_4)_{ijk}}{\Lambda}(Q_i H_d)(U_j^c E_k^c) + \frac{(\kappa_5)_{ij}}{\Lambda}(L_i L_j)(H_u H_u) + \frac{(\kappa_6)_i}{\Lambda}(L_i H_d)(H_u H_u), \end{aligned} \quad (4)$$

where  $\Lambda$  can be viewed here as the scale of new physics, beyond MSSM. It is easy to check that the operators  $\kappa_1$ ,  $\kappa_2$  and  $\kappa_5$  do respect R-parity but still violate  $B$  and  $L$  and are experimentally constrained to be rather small.

On the other hand, in models without R-parity, the experimental signatures are spectacular: single production of supersymmetric particles accompanied by missing energy, which could be observed at lower energies compared to the R-parity conserving case, sizable effects in the flavour physics, etc. The study of these effects in the near future in the accelerators is the main purpose of our report.

The plan of this report is the following. In Section 2, an updated and improved analysis on  $R$ -violating couplings coming from the various existing data is made. Then, in Section 3 we discuss theoretically motivated

<sup>1</sup>the expression of  $W_2$  developed in terms of fields is given in appendix B

alternatives to R-parity based on abelian family symmetries, relating the couplings  $\lambda$ ,  $\lambda'$  and  $\lambda''$  to the ordinary Yukawa couplings. In Sections 4 the single production of supersymmetric particles at LEP, Tevatron and LHC are discussed and in Sections 5,6,7 we study in more detail the physics of R-parity violating couplings at HERA, LEP and LHC. In Section 8 we discuss the implications of R-parity violation on neutrino masses, which seems to find a more solid evidence in view of the last results at SuperKamiokande. We end with our projects and perspectives for the next two years.

## 2 Indirect bounds on $R$ -parity odd interactions

The indirect bounds concern essentially the constraints deduced from low and intermediate energy particle, nuclear, atomic physics or astrophysics phenomenology, where the superpartners of ordinary particles propagate off-shell in (tree or loop) Feynman diagrams. The interest in this subject dates back to the early period of the  $R$ -parity literature, see [1] to [15], and still continues to motivate a strong activity [16, 17]. By contrast, the subject of direct bounds or measurements rather deals with the high energy colliders physics phenomenology (single production, LSP decays, etc...) with superpartners produced on the mass shell. To extract an experimental information on the 3 dimensionfull coupling constants,  $\mu_i$ , which mix the up Higgs boson  $H_u$  with leptons, and the 45 dimensionless Yukawa coupling constants,  $\lambda_{ijk} = -\lambda_{jik}$ ,  $\lambda'_{ijk}$ ,  $\lambda''_{ijk} = -\lambda''_{ikj}$ , one must define some search strategy and look for reasonably motivated assumptions. It is important to note first that an independent discussion of the bilinear interactions is necessary only for the case where the left-handed sneutrinos acquire, at the stage of electroweak gauge symmetry breaking, non-vanishing VEVs,  $\langle \tilde{\nu}_i \rangle = v_i$ . In the alternate explicit breaking case, characterized by  $v_i = 0$ , one can by a field transformation remove away the bilinear interactions in favor of the trilinear and higher dimension interactions. The case of a spontaneously broken discrete symmetry may be characterized rather by,  $\mu_i = 0$ ,  $v_i \neq 0$  or by the hypothetical situation where right-handed sneutrino raises a VEV. Strong bounds on these parameters have been deduced in both the explicit and spontaneous breaking cases.

Concerning the trilinear coupling constants, the major part of the existing experimental indirect bounds has been derived on the basis of the so-called single coupling hypothesis, where a single coupling constant is assumed to dominate over all the others, so that each of the coupling constants contributes once at a time [12, 13]. Apart from a few isolated cases, the typical bounds derived under this hypothesis, assuming a linear dependence on the superpartner masses, are of order,  $[\lambda, \lambda', \lambda''] < (10^{-1} - 10^{-2}) \frac{\tilde{m}}{100 \text{ GeV}}$ .

An important variant of the single operator dominance hypothesis can be defined by applying this at the level of the gauge (current) basis fields rather than the mass eigenstate fields. This appears as a more natural assumption in models where the presumed hierarchies in coupling constants originate from physics at higher scales. As an illustration, we quote two useful representations of the  $\lambda'$  interactions, obtained by performing the linear transformations on quarks fields from current to mass eigenstates bases,

$$\begin{aligned} W(\lambda') &= \lambda'_{ijk} (\nu_i d_j - e_i u_j) d_k^c = \lambda'^A_{ijk} (\nu_i d'_j - e_i u_j) d_k^c = \lambda'^B_{ijk} (\nu_i d_j - e_i u'_j) d_k^c, \\ \lambda'^A_{ijk} &= \lambda'_{imn} (V_L^{u\dagger})_{mj} (V_R^{dT})_{nk}, \quad d'_i = V_{il} d_l; \quad \lambda'^B_{ijk} = \lambda'_{imn} (V_L^{d\dagger})_{mj} (V_R^{dT})_{nk}, \quad u'_i = (V^\dagger)_{il} u_l, \end{aligned} \quad (5)$$

where  $V = V_{CKM}$  is the familiar quarks unitary CKM matrix. The representations with the coupling constants,  $\lambda'^A_{ijk}$  or  $\lambda'^B_{ijk}$ , allow for the presence of flavour changing contributions in the d-quark or u-quark sectors, respectively, even when a single  $R$ -parity odd coupling constant is assumed to dominate [20].

To the extent that there is no preferred basis for fields, it is useful to look for basis independent statements. Thus, the two sets of mass basis coupling constants,  $\lambda'^{A,B}$  and the current basis coupling constants,  $\lambda'$ , obey the unitarity (sum rule) type relations,  $\sum_{jk} |\lambda'^{A,B}_{ijk}|^2 = \sum_{jk} |\lambda'_{ijk}|^2$ . A classification of all possible invariant products of the  $\mathcal{R}_p$  coupling constants has been examined in [21]. Assuming that the linear transformation matrices,  $V_{L,R}^{q,l}$ , were known, and that one is given a bound on some interaction operator, then by applying the single dominance hypothesis to the current basis coupling constants, one could derive a string of bounds associated to the operators which mix with it by the current-mass fields transformations. For example, assuming  $(V_L^u)_{1i} = (V_R^u)_{1i} = (1, \epsilon, \epsilon')$ , starting from the bound on  $\lambda'_{111}$ , one can deduce the following related bounds:  $\lambda'_{121} < \lambda'_{111}/\epsilon$ ,  $\lambda'_{131} < \lambda'_{111}/\epsilon'$ , [22].

At the next level of complexity, one may apply an extended hypothesis where the dominance is postulated for pair, triple, etc... products of coupling constants. Several analyses dealing with hadron flavour changing effects (mixing parameters for the neutral light and heavy flavoured mesons, mesons decays,  $K \rightarrow \pi + \nu + \bar{\nu}$ , ... [20, 23, 24]); lepton flavour changing effects (leptons decays,  $l_i^\pm \rightarrow l^\pm + l_n^- + l_p^+$ , [23] conversion processes,  $\mu^- \rightarrow e^-$  [25], neutrinos Majorana mass [10, 26], ...); lepton number violating effects (neutrinoless double beta decay [27, 28, 29]); or baryon number violating effects (proton decay partial branchings [30], rare non-leptonic decays of heavy mesons [31], nuclei desintegration [32],...) have led to bounds on a large number of quadratic products of the coupling constants.

Our purpose in this work is to present an encapsulated review of the literature on indirect bounds, which complements the existing reviews [16, 17]. Our main objective is to identify certain important unsettled problems where effort is needed. The contents of this chapter are organized into 4 sections. Subsection 2.1 is about the bilinear interactions and spontaneously broken realization of  $R$ -parity. Subsection 2.2 is about the trilinear interactions. Subsection 2.3 reviews a variety of scattering and decay processes associated with lepton and

baryon number and lepton and quark flavour violations. Section 2.4 presents the main conclusions. Some important notations used in the sequel are summarized in appendix A.

## 2.1 Bilinear interactions and spontaneously broken $R$ -parity

The bilinear interactions,  $W = \mu_i H_u L_i$ , break  $R$ -parity and  $L_i$  numbers. The physical effects of these interactions bear on the parameters,  $\mu_i$ , and the sneutrinos VEVs,  $\langle \tilde{\nu}_i \rangle = v_i$ . It is important to distinguish the cases of a spontaneously broken  $R$ -parity,  $\mu_i = 0$ ,  $v_i \neq 0$ , from the explicit breaking one,  $\mu_i \neq 0$ ,  $v_i$  vanishing or not. The viable models constructed so far, employ either the explicit breaking option or a specific spontaneous breakdown option where  $R$ -parity and lepton numbers are broken by a right-handed neutrino VEV,  $\langle \tilde{\nu}_R \rangle \neq 0$ , so as to have a gauge singlet Goldstone boson (so-called majoron) which is decoupled from gauge interactions [8, 9, 35, 36]. One expects the two sets of parameters,  $\mu_i$ ,  $v_i$ , to be strongly correlated, since  $\mu_i \neq 0$  may by themselves lead, through minimization of the scalar potential, to non vanishing VEVs,  $v_i \neq 0$ , at electroweak symmetry breaking [37, 38]. As long as one makes no commitment regarding the structure of the effective potential for the scalar fields, the four-vector of VEVs,  $v_\alpha$ , must be regarded as free parameters.

In the limit of vanishing superpotential, the minimal supersymmetric Standard Model possesses an  $SU(4)$  global symmetry which transforms the column vector of down Higgs boson and leptons chiral supermultiplet fields,  $L_\alpha = (H_d \ L_i)$ , as,  $(H_d \ L_i) \rightarrow U(H_d \ L_i)$ ,  $U \in SU(4)$ , where the indices,  $\alpha = [d, i]$ , [ $i = (1, 2, 3) = (e, \mu, \tau)$ ], label the down-type Higgs bosons and the three lepton families. The symmetry group  $SU(4)$  reduces to  $SU(3)$  by switching on the bilinear (d=3)  $R$ -parity odd superpotential,  $W = \mu_\alpha H_u L_\alpha$ , and is completely broken down by switching on the matter Higgs bosons trilinear interactions. For vanishing  $v_i$ , one can apply the superfields transformation,  $U \approx \begin{pmatrix} 1 & -\delta_m \\ \delta_m & I_3 \end{pmatrix}$ , with  $\delta_m = \frac{\mu_m}{\mu}$ , so as to rotate away the lepton-Higgs boson mixing terms, leaving behind the Higgs bosons mixing superpotential,  $W_2 = \mu H_u H_d$ , along with trilinear  $R$ -parity odd interactions of specific structure,  $\lambda_{ijk} = -(\lambda_e)_{ik} \delta_j$ ,  $\lambda'_{ijk} = -(\lambda_d)_{ik} \delta_j$ .

For non-vanishing three-vector of VEVs,  $\langle \tilde{\nu}_i \rangle = v_i$ , the remnant  $SU(3)$  symmetry is spontaneously broken down to  $SU(2)$ . This induces bilinear mass terms which mix neutrinos with neutralinos and charged leptons with charginos. The condition that the six eigenvalues of the neutralinos mass matrix can be assigned to the two massless,  $\nu_e, \nu_\mu$ , neutrinos, the  $\nu_\tau$  neutrino of mass  $m_{\nu_\tau}$ , and the three massive neutralinos of mass  $O(M_Z)$ , imposes [38] the order of magnitude bounds,  $v_i < O(\sqrt{M_Z m_{\nu_\tau}})$ ,  $\mu_i < O(\sqrt{M_Z m_{\nu_\tau}})$ , along with the order of magnitude alignment condition,  $\sin^2 \psi < O(\frac{m_{\nu_\tau}}{M_Z})$ . From the experimental bounds on neutrinos masses:  $m_{\nu_{[e, \mu, \tau]}} < [5.1eV, 160keV, 24MeV]$ , we conclude that these strong bounds affect not only the  $\mathcal{R}_p$  coupling constants,  $\mu_i$ , but also place restrictive conditions on the soft susy breaking parameters via the sneutrinos VEVs vector,  $v_i$ . In the simpler case involving a single generation of leptons, say the third, the mass bound on  $\nu_\tau$  yields,  $v_\tau < 5 \text{ GeV}$  [36]. For the general three generation case, in a suitable approximation, there arises a single massive Majorana neutrino given by the fields linear combination,  $\nu_M(x) = \frac{1}{(\sum_j v_j^2)^{\frac{1}{2}}} \sum_i v_i \nu_i(x)$ . If this

is identified with  $\nu_\tau$ , then the associated mass bound (using,  $m_{\nu_M} < 143 \text{ MeV}$ , rather than the stronger current experimental bound) yields a bound on the quadratic form,  $(\sum_i v_i^2)^{\frac{1}{2}} < 12 - 24 \text{ GeV}$  [6, 7, 10]. If it is identified instead with  $\nu_e$ , the stronger bound  $(\sum_i v_i^2)^{\frac{1}{2}} < 2 - 5 \text{ MeV}$  results. The mixing of neutrinos with neutralinos may also induce new desintegration channels for the Z-boson consisting of single production of superpartners. The Z-boson current coupling to neutralinos pairs,  $Z^0 \rightarrow \tilde{\chi}_l^0 + \tilde{\chi}_l^0$ , leads through the  $\nu_\tau - \chi_l^0$  mixing to the decay channels,  $Z \rightarrow \tilde{\nu}_\tau + \tilde{\chi}_l^0$ . Similarly, the mixing of  $\tau^\pm$  with charginos, induces the decay channels,  $Z^0 \rightarrow \tau^+ + \tilde{\chi}^-$ , ... The associated Z-boson decay BF range inside the interval,  $10^{-5} - 10^{-7}$  [36].

Neutrinos Majorana masses and mixing parameters can also be induced via one-loop mechanisms involving the  $\lambda'$  interactions in combination with tadpoles of sneutrinos [6, 7, 10]. The experimental bounds on masses lead to bounds on the following products:  $\lambda_{ilm} (\frac{v_i}{10MeV}) < (\frac{\tilde{m}}{250GeV}) [10^2, 1.5 \cdot 10^4, 1.6 \cdot 10^5]$ , [ $i = 1, 2, 3$ ] [10]. One-loop mechanisms may also contribute to the rare forbidden processes,  $\mu^- \rightarrow e^- + \gamma$ ,  $\mu^- \rightarrow e^- + e^+ + e^-$ , (where the current experimental bounds are,  $B(\mu \rightarrow e + \gamma) < 4.9 \cdot 10^{-11}$ ,  $B(\mu \rightarrow e + e + e) < 1.0 \cdot 10^{-12}$ ) or to neutralino LSP decays,  $\chi^0 \rightarrow \nu + \gamma, \dots$ , which may have implications on cosmology. For a very light neutralino LSP case, exotic pions decay reactions such as,  $\pi \rightarrow e + \tilde{\chi}^0$ , etc... [6] are possible. Implications on  $\tilde{\nu}\tilde{\nu}$  oscillations and bounds on sneutrinos Majorana-like masses,  $L = -\frac{1}{2}(\tilde{m}_M \tilde{\nu}\tilde{\nu} + c.c.)$ , have also been examined [39].

## 2.2 Trilinear interactions



## 2.2.1 Four-fermions contact interactions

Under the single dominant coupling constant hypothesis, the neutral current four-fermion (dimension-6) interactions induced by decoupling of exchanged scalar superpartners at tree level, can be represented by the effective Lagrangian:

$$L_{EFF} = \sum_{ijk} \frac{1}{2} |\lambda_{ijk}|^2 \left[ \frac{1}{m_{\tilde{e}_{kR}}^2} (\bar{\nu}_{iL} \gamma_\mu \nu_{iL}) (\bar{e}_{jL} \gamma^\mu e_{jL}) - \frac{1}{m_{\tilde{e}_{kR}}^2} (\bar{\nu}_{jL} \gamma_\mu e_{jL}) (\bar{e}_{iL} \gamma^\mu \nu_{iL}) \right. \\ \left. - \frac{1}{m_{\tilde{\nu}_{iL}}^2} (\bar{e}_{jL} \gamma_\mu e_{jL}) (\bar{e}_{kR} \gamma^\mu e_{kR}) - \frac{1}{m_{\tilde{\nu}_{iL}}^2} (\bar{\nu}_{jL} \gamma_\mu \nu_{jL}) (\bar{e}_{kR} \gamma^\mu e_{kR}) + (i \rightarrow j) \right] + h.c. . \quad (6)$$

An analogous formula holds for the  $\lambda'_{ijk}$  interactions with the substitutions,  $\nu_{[i,j]L} \rightarrow u_{[i,j]L}$ ,  $e_{jL} \rightarrow d_{jL}$ ,  $e_{kR} \rightarrow d_{kR}$ . The neutral current (NC) contact interactions can include scalar, vector or tensor Lorentz covariants. The least strongly constrained of these three couplings, so far, are the vector interactions. The conventional parametrization for leptons-quarks flavour diagonal couplings reads,

$$L_{NC} = \sum_{ij=L,R} \frac{4\pi\eta_{ij}^q}{\Lambda_{ij}^{\eta^2}} (\bar{e}_i \gamma_\mu e_i) (\bar{q}_j \gamma_\mu q_j),$$

where a sum over light flavours of leptons and quarks is understood and  $\eta_{ij}^q = \pm 1$  are sign factors. The analyses of these interactions at high energy colliders are directed towards tests of non-resonant continuum contributions associated to composite (technicolor, ...) models of quarks and leptons, leptoquarks, ...[40]. Bounds of magnitude,  $\Lambda_{[LR,RL]}^{[-,+d]} > [1.4, 1.6]$  TeV, are reported by ALEPH, DELPHI and OPAL Collaborations at LEP [41] (based on the reactions,  $e^- e^+ \rightarrow s\bar{s}, \dots$ ), and  $\Lambda_{[LR,RL]}^{[+,+u]} > [2.5, 2.5]$  TeV, by CDF Collaboration at the Tevatron [42] (based on Drell-Yan processes or large  $p_T$  jets production). The recent anomalous events observed by the H1 and ZEUS Collaborations at HERA seem to favor a small scale,  $\Lambda \approx 1$  TeV [43, 44].

The charged current (CC) four-fermions contact interactions have a Lorentz vector component, which is conventionally parametrized as,

$$L_{CC} = \frac{4\pi\eta}{\Lambda_{CC}^{\eta^2}} (\bar{e}_L \gamma_\mu \nu_L) (\bar{u}_L \gamma_\mu d'_L).$$

While the bounds obtained by the Collaborations at the LEP or Tevatron colliders lie typically at,  $\Lambda_{CC}^- > 1.5 TeV$ , the fit to the recent deep inelastic scattering events observed by the Collaborations at the HERA collider ( $\sqrt{s} = 300 GeV$ ,  $Q^2 > 15,000 GeV^2$ ) favor again lower values,  $\Lambda_{CC} = 0.8 - 1 TeV$  [45]. Let us note here that the bounds from leptons and hadrons universality decays, APV etc..., to be discussed below, generally point to larger cut-off scales,  $\Lambda \approx 10 - 30$  TeV, and  $\Lambda_{CC} \approx 10 - 80$  TeV.

Under the hypothesis of dominant pairs of coupling constants, there arise mixed leptons-quarks four-fermion  $\mathcal{R}_p$  induced interactions, of which a subset reads:

$$L_{EFF} = -\frac{1}{m_{\tilde{\nu}_{iL}}^2} \lambda'_{ijk} \lambda_{imn}^* (\bar{d}_{kR} d'_{jL}) (\bar{e}_{mL} e_{nR}) - \frac{1}{2m_{\tilde{u}_{jL}}^2} \lambda'_{ijk} \lambda_{jn}^* (\bar{d}_{kR} \gamma_\mu d_{nR}) (\bar{e}_{iL} \gamma^\mu e_{iL}) \\ + \frac{1}{2m_{\tilde{d}_{kR}}^2} \lambda'_{ijk} \lambda_{lmk}^* (\bar{e}_{iL} \gamma_\mu e_{iL}) (\bar{u}_{mL} \gamma^\mu u_{jL}) - \frac{1}{m_{\tilde{\nu}_{iL}}^2} \lambda'_{ijk} \lambda_{imn}^* (\bar{d}_{kR} d'_{jL}) (\bar{d}'_{mL} d_{nR}). \quad (7)$$

These interactions can induce contributions to rare leptonic decay processes of mesons. The bounds on the  $\mathcal{R}_p$  coupling constants obtained from the leptonic decays of light quarks mesons are:

$(\lambda'_{l11} \lambda'_{l12} \pm \lambda'_{l11} \lambda_{l21}) < 0.14$ ,  $[\pi^0 \rightarrow e^- + \mu^+]$  [25];  $\lambda_{122} \lambda'_{112,121} < 3.8 \cdot 10^{-7}$ ,  $[K_L \rightarrow \mu^+ \mu^-]$ ,  $\lambda_{121} \lambda'_{212,221} < 2.5 \cdot 10^{-8}$ ,  $[K_L \rightarrow e^+ e^-]$ ,  $\lambda_{122} \lambda'_{212,221} < 2.3 \cdot 10^{-8}$ ,  $[K_L \rightarrow e^+ \mu^-]$  [23].

For leptonic decays of heavy quarks mesons, some bounds reported in the literature, all in units of,  $(\frac{\tilde{m}}{100 GeV})^2$ , are:

(1)  $\lambda_{131} \lambda'_{333} < 0.075 e_{3L}^2$ ,  $[B \rightarrow e^- + \bar{\nu}]$ ;  $\lambda'_{333} < 0.32 \tilde{m}^2$ ,  $[B^- \rightarrow \tau^- + \bar{\nu}]$ ;  $\lambda_{131} \lambda'_{333} < 0.075 \tilde{m}^2$ ,  $[B^- \rightarrow e^- + \bar{\nu}]$ ; [46]

(2)  $\lambda_{121} \lambda'_{131} < 4.5 \cdot 10^{-5} \tilde{m}^2$ ,  $[B \rightarrow e^+ + \mu^-]$ ;  $\lambda_{131} \lambda'_{131} < 5 \cdot 10^{-4} \tilde{m}^2$ ,  $[B \rightarrow e^+ + \tau^-]$ ;  $\lambda_{123} \lambda'_{131} < 6 \cdot 10^{-4} \tilde{m}^2$ ,  $[B \rightarrow \mu^+ + \tau^-]$  [24].

## 2.2.2 Charged current interactions

•• **Lepton families universality.** Corrections to the leptons charged current universality in the  $\mu$ -decay process,  $\mu^- \rightarrow e^- + \nu_\mu + \bar{\nu}_e$ , arise at tree level from the  $\mathcal{R}_p$  interactions. These redefine the Fermi weak interactions constant as [13],  $\frac{G_\mu}{\sqrt{2}} = \frac{g^2}{8M_W^2}(1 + r_{12k}(\tilde{e}_{kR}))$ .

The redefinition,  $G_\mu \rightarrow G_\mu/(1 + r_{12k}(\tilde{e}_{kR}))$ , can be tested at the quantum level of the Standard Model by testing the exact relations, linking the different basic coupling constants, which incorporate the one-loop renormalization corrections [47]. The following two relevant relationships:

$$m_W^2 = \frac{\pi\alpha}{\sqrt{2}G_\mu \sin^2 \theta_W(m_Z)|_{\overline{MS}}(1 - \Delta r(m_Z)|_{\overline{MS}})}, \quad \left(\frac{m_W}{m_Z}\right)^2 = 1 - \frac{\pi\alpha}{\sqrt{2}G_\mu m_W^2(1 - \Delta r(m_Z)|_{\overline{MS}})},$$

link the renormalized W-boson mass and coupling constant parameters,  $m_W, \alpha, G_\mu, \sin^2 \theta_W$ , with the combination of radiative corrections,  $\Delta r = 2\delta e/e - 2\delta g/g - \tan^{-2} \theta_W(\delta m_W^2/m_W^2 - \delta m_Z^2/m_Z^2)$ . Recall that the input parameters employed in high precision tests of the Standard Model are chosen as the subset of best experimentally determined parameters among the following basic set:  $\alpha^{-1} = 137.036$ ,  $\alpha_s = 0.122 \pm 0.003$ ,  $m_Z = 91.186(2)$ ,  $G_\mu = 1.16639(1) 10^5 GeV^{-2}$ ,  $m_{top}(pole) = 175.6 \pm 5.0, m_{Higgs}$ . The remaining parameters are then deduced by means of fits to the familiar basic data (Z-boson lineshape and decay widths,  $\tau$  polarization, forward-backward (FB) or polarization asymmetries, atomic parity violation (APV), beta decays, masses, ...) Unfortunately, at the present level of precision for the fitted Standard Model parameters,  $(m_Z, m_W, \dots)$  no useful bound can be deduced on  $\lambda_{12k}$ .

The same interactions also govern  $\mathcal{R}_p$  corrections in the  $\tau$ -lepton decay process,  $\tau^- \rightarrow e^- + \nu_\tau + \bar{\nu}_e$ , and related three-body beta decay processes. The corrected BFs read [13],

$$R_\tau = \frac{\Gamma(\tau \rightarrow e + \bar{\nu}_e + \nu_\tau)}{\Gamma(\tau \rightarrow \mu + \bar{\nu}_\mu + \nu_\tau)} \simeq R_\tau^{SM}[1 + 2(r_{13k}(\tilde{e}_{kR}) - r_{23k}(\tilde{e}_{kR}))]. \quad (8)$$

$$R_{\tau\mu} = \frac{\Gamma(\tau \rightarrow \mu + \bar{\nu}_\mu + \nu_\tau)}{\Gamma(\mu \rightarrow e + \bar{\nu}_e + \nu_\mu)} \simeq R_{\tau\mu}^{SM}[1 + 2(r_{23k}(\tilde{e}_{kR}) - r_{12k}(\tilde{e}_{kR}))]. \quad (9)$$

These interactions can also contribute to the pseudoscalar mesons two-body leptonic decays of charged pions,  $\pi^- \rightarrow l_i^- + \bar{\nu}_j$ . The  $\mathcal{R}_p$  corrections lead to the corrected BFs [13]:

$$R_\pi = \frac{\Gamma(\pi^- \rightarrow e^- + \bar{\nu}_e)}{\Gamma(\pi^- \rightarrow \mu^- + \bar{\nu}_\mu)} \simeq R_\pi^{SM}[1 + \frac{2}{V_{ud}}(r'_{11k}(\tilde{d}_{kR}) - r'_{21k}(\tilde{d}_{kR}))]. \quad (10)$$

•• **Light quarks and leptons universality.** The experimental information on light quarks charged current interactions is deduced from data on neutron and nuclear beta decay reactions in terms of the Fermi coupling constant,  $G_F$ , or equivalently the CKM matrix element,  $V_{ud}$ . The  $\mathcal{R}_p$  corrections to the d-quark decay subprocess,  $d \rightarrow u + W^- \rightarrow u + e^- + \bar{\nu}_e$ , combined with the above redefinition of  $G_\mu$ , yields a redefined CKM matrix element:

$$|V_{ud}|^2 = \frac{|V_{ud}^0 + r'_{11k}(\tilde{d}_{kR})|^2}{|1 + r_{12k}(\tilde{e}_{kR})|^2}.$$

Application to the s- and b-quarks decays yields analogous formulas for  $V_{us}$  and  $V_{ub}$ , which can be deduced from the formula for  $V_{ud}$  by the substitutions,  $r'_{11k} \rightarrow r'_{12k}$  and  $r'_{13k}$ , respectively [48]. Improved bounds obtained from tree and one-loop contributions to D-mesons beta decays are [48]:

$$\lambda'_{22k} < 0.30, [D^*] 0.49, [D^+] 0.13, [D^0]; \lambda'_{12k} < 0.10, [D^*] 0.28, [D^+] 0.21, [D^0].$$

•• **Universality in  $\tau$ -lepton and mesons semi-leptonic decays.** The  $\mathcal{R}_p$  contributions to the decay processes into pseudoscalar and vector mesons,  $\tau^- \rightarrow l^- + P^0$ , and  $\tau^- \rightarrow l^- + V^0$ , [ $P = \pi^0, \eta, K$ ;  $V = \rho^0, \omega, K^*$ ] arise through tree level exchange of sneutrinos, [25]. The bounds deduced from upper limits on experimental rates are:  $\lambda_{k31}\lambda'_{k11} < 6.4 10^{-2}\tilde{\nu}_{kL}^2$ . Several other analogous bounds are also quoted in [25]. The  $\mathcal{R}_p$  induced decay process,  $\tau^- \rightarrow \pi^- + \nu_\tau$ , yields the bound [25]:  $\lambda'_{31k} < 0.16 \tilde{d}_{kR}$ . From the formally related ratios of decay widths  $\tau$ -lepton hadronic and  $\pi$ -meson leptonic decays,  $\Gamma(\tau^- \rightarrow \pi^- + \nu_\tau)/\Gamma(\pi^- \rightarrow \mu^- + \nu_\mu)$ , one also deduces [48]:  $\lambda'_{31k} < 0.10 \tilde{d}_{kR}$ ,  $\lambda'_{21k} < 0.03 \tilde{d}_{kR}$ .

The decay processes,  $D^+ \rightarrow \bar{K}^0(K^*) + \mu^+ + \nu_\mu$ ,  $D^0 \rightarrow K^- + \mu^+ + \nu$  and related processes involving the other leptons, are induced through the  $\mathcal{R}_p$  interactions by tree level  $\tilde{d}_{kR}$  exchange, The current experimental upper limits on the BF for these processes yield the bounds [49]:

$$\lambda'_{121,123} < 0.29; [D^+ \rightarrow \bar{K}^0] \lambda'_{22k} < 0.18; [D^+ \rightarrow \bar{K}^{0*}] \lambda'_{121,123} < 0.34 [D^0 \rightarrow K^-].$$

The analysis of tree level  $\mathcal{R}_p$  contributions to the D-mesons three-body decay,  $D \rightarrow K+l+\nu$ ,  $D \rightarrow K^*+l+\nu$  [49], yields the bounds,

$$\lambda'_{12k=[1,3]} < 0.34, \lambda'_{22k} < 0.18, \lambda'_{31k} < 0.16.$$

For the  $B^-$  meson decay processes, one finds the bound:

$$\lambda'_{333} < 0.12(\frac{m_d}{100G_eV}), [B^- \rightarrow X_q + \tau^- + \bar{\nu}], [50].$$

•• **Summary of charged current experimental bounds.** Building on the initial analysis [13] where the tree level Standard Model predictions were used, the analysis in [48] combined both tree and one-loop level contributions. The combined list, including the refined updated  $1\sigma$  bounds from [48], is given below.

$$\lambda_{12k} : 0.04e_{kR} [V_{ud}]; 0.14 \pm 0.05e_{kR} \text{ } 0.05e_{kR}[R_{\tau\mu}];$$

$$\lambda_{13k} : 0.05e_{kR} [R_{\tau}];$$

$$\lambda_{23k} : 0.05e_{kR}, [R_{\tau}]; 0.05e_{kR} [R_{\tau\mu}];$$

$$\lambda'_{11k} : 0.01d_{kR} [V_{ud}].$$

$$\lambda'_{12k} : 0.04d_{kR} [V_{us}].$$

$$\lambda'_{13k} : 0.37d_{kR} [V_{ub}].$$

$$\lambda'_{21k} : 0.05d_{kR} [R_{\pi}].$$

## 2.2.3 Neutral current interactions

•• **Neutrinos-leptons and quarks-leptons elastic scattering.** The elastic  $\nu_\mu$  scattering processes,  $\nu_\mu + e_i \rightarrow \nu_\mu + e_j$ ,  $\nu_\mu + q_i \rightarrow \nu_\mu + q_j$ , at energies well below  $m_Z$ , are described at tree level by Z-boson exchange contributions in terms of the effective Lagrangian,

$$L = -\frac{4G_F}{\sqrt{2}}(\bar{\nu}_L\gamma_\mu\nu_L)(g_L^f\bar{f}_L\gamma^\mu f_L + g_R^f\bar{f}_R\gamma^\mu f_R). \quad (11)$$

The related  $\nu_e$  scattering processes include an additional  $t$ -channel contribution. The  $\mathcal{R}_p$  corrections read, [13]

$$\begin{aligned} g_L^e &= (-\frac{1}{2} + x_W)(1 - r_{12k}(\tilde{e}_{kR})) - r_{12k}(\tilde{e}_{kR}), \quad g_R^e = x_W(1 - r_{12k}(\tilde{e}_{kR})) + r_{211}(\tilde{e}_{1L}) + r_{231}(\tilde{e}_{3L}), \\ g_L^d &= (-\frac{1}{2} + \frac{1}{3}x_W)(1 - r_{12k}(\tilde{e}_{kR})) - r'_{21k}(\tilde{d}_{kR}), \quad g_R^d = \frac{x_W}{3}(1 - r_{12k}(\tilde{e}_{kR})) + r'_{2j1}(\tilde{d}_{jL}). \end{aligned} \quad (12)$$

•• **Fermion-antifermion pair production.** The forward-backward angular asymmetries (FB) in the differential cross sections for the reactions,  $e^+ + e^- \rightarrow f + \bar{f}$ , [ $f = l, q$ ] can be parametrized in terms of the axial vector coupling in the effective Lagrangian density,  $L = -\frac{4G_F}{\sqrt{2}}A^e A^f(\bar{e}\gamma_\mu\gamma_5 e)(\bar{f}\gamma^\mu\gamma_5 f)$ , where,  $A^f = -T_{3L}^f$ . The off Z-boson pole asymmetry is defined as,  $A_{FB} = -\frac{3G_F s m_Z^2}{16\sqrt{2}\pi\alpha(m_Z^2 - s)}$ , and the Z-boson pole asymmetry as,  $A_{FB} = \frac{3}{4}A^e A^{l,q}$ . The formulas for the  $\mathcal{R}_p$  corrections to the Z-pole asymmetries in terms of the products of parameters  $A^e A^f$  read [13],

$$\begin{aligned} A^e A^\mu &= \frac{1}{4} - \frac{1}{2}r_{ijk}(\tilde{\nu}_{kL}), \quad \left[ (ijk) = (122), (132), (121), (321) \right] \\ A^e A^\tau &= \frac{1}{4} - \frac{1}{2}r_{ijk}(\tilde{\nu}_{kL}), \quad \left[ (ijk) = (213), (313), (131), (231) \right] \\ A^e A^{u_j} &= -\frac{1}{4} - \frac{1}{2}r'_{1jk}(\tilde{d}_{kL}); \quad A^e A^{d_k} = \frac{1}{4} - \frac{1}{2}r'_{1jk}(\tilde{u}_{jL}). \end{aligned} \quad (13)$$

•• **Atomic parity violation (APV).** The conventional parametrization for the effective flavour-diagonal interaction between leptons and quarks is,

$$L = \frac{G_F}{\sqrt{2}} \sum_{i=u,d} C_1(i)(\bar{e}\gamma_\mu\gamma_5 e)(\bar{q}_i\gamma^\mu q_i) + C_2(i)(\bar{e}\gamma_\mu e)(\bar{q}_i\gamma^\mu\gamma_5 q_i). \quad (14)$$

Combining the Standard Model Z-boson pole contributions with those of the  $\mathcal{R}_p$  interactions yields [13]:

$$\begin{aligned} C_1(u) &= (-\frac{1}{2} + \frac{4}{3}x_W)(1 - r_{12k}(\tilde{e}_{kR})) - r'_{11k}(\tilde{d}_{kR}), \quad C_2(u) = (-\frac{1}{2} + 2x_W)(1 - r_{12k}(\tilde{e}_{kR})) - r'_{11k}(\tilde{d}_{kR}); \\ C_1(d) &= (\frac{1}{2} - \frac{2}{3}x_W)(1 - r_{12k}(\tilde{e}_{kR})) + r'_{1j1}(\tilde{q}_{jL}), \quad C_2(d) = (\frac{1}{2} - 2x_W)(1 - r_{12k}(\tilde{e}_{kR})) - r'_{1j1}(\tilde{q}_{jL}). \end{aligned} \quad (15)$$

An important experimental parameter in the APV phenomenology [51] is the weak charge,  $Q_W = -2[(A + Z)C_1(u) + (2A - Z)C_1(d)]$ . For the reference case of the  $^{133}\text{Cs}$  atom, the discrepancy between experimental and Standard Model fitted values is:  $\delta(Q_W) = Q_W^{exp} - Q_W^{SM} = (-72.41 \pm 0.84) + (73.12 \pm 0.09) = 0.71 \pm 0.84$ . A refined analysis in [43] yields:  $\lambda'_{1j1} < 0.028\tilde{q}_j$ .

•• **Z-boson pole observables.** The corrections to the Standard Model predictions to the leptonic BF (averaged over families) and the b-quarks Z-boson decays BF,  $R_l^Z = \Gamma_h/\Gamma_l$ ,  $R_b^Z = \Gamma_b/\Gamma_h$ , can be expressed as:  $\delta R_l \equiv \frac{R_l}{R_l^{SM}} - 1 = -R_l^{SM}\Delta_l + R_l^{SM}R_b^{SM}\Delta_l$ ,  $\delta R_b = R_b^{SM}\Delta_b(1 - R_b^{SM})$ , where  $\Delta_f = \frac{\Gamma(Z \rightarrow f\bar{f})}{\Gamma_{SM}(Z \rightarrow f\bar{f})} - 1$ . The fitted Standard Model values [34] are:  $R_l = 20.786$ ,  $R_b = 0.2158$ ,  $R_c = 0.172$ , while the experimental values [34] are:  $R_l = 20.795 \pm 0.04$ ,  $R_b = 0.2202 \pm 0.0020$ ,  $R_c = 0.1583 \pm 0.0098$ . The  $R_p$  corrections to these BF may be induced at one-loop level via fermions-sfermions intermediate states [52].

•• **Summary of neutral current experimental bounds.** The list of bounds from a tree level analysis is given below.

$$\begin{aligned}
\lambda_{12k} &: 0.34e_{kR}, 0.29e_{k=1L} [\nu_\mu + e]; [0.10, 0.10, 0.24] \nu_{kL} [A_{FB}]. \\
\lambda_{13k} &: [0.10, 0.10, 0.24] \nu_{kL} [A_{FB}]. \\
\lambda_{23k} &: 0.26e_{k=3L} [\nu_\mu + e]; [0.10, 0.24] \nu_{k=1,2L} [A_{FB}]. \\
\lambda'_{11k} &: 0.26q_{k=3L} [A_{FB}]; 0.30d_{kR}, 0.26q_{k=1L} [APV]; \\
\lambda'_{12k} &: 0.45d_{kR}, 0.26q_{k=3L} [A_{FB}]; 0.26q_{k=1L} [APV]; 0.29 \tilde{d}_{kR} [D^* \rightarrow \bar{K}^*] \\
\lambda'_{13k} &: 0.45q_{k=3L}, [A_{FB}]; 0.26q_{k=1L} [APV]; 0.63 [R_{l,b}^Z] \\
\lambda'_{21k} &: 0.11d_{kR}, 0.22d_{k=1L} [\nu + q]; \\
\lambda'_{22k} &: 0.22d_{k=2L} [\nu_\mu + q]; 0.18 \tilde{d}_{kR} [D \rightarrow \bar{K}] \\
\lambda'_{23k} &: 0.22d_{k=1L} [\nu_\mu + q]; 0.44 [R_\mu]; 0.56 [R_{l,b}^Z] \\
\lambda'_{31k} &: 0.16 \tilde{d}_{kR} [\tau \rightarrow \pi + \nu] . \\
\lambda'_{32k} &: 0.36 [48]. \\
\lambda'_{33k} &: 0.26 [R_\tau^Z]; 0.45 [R_{l,b}^Z]; 0.6 - 1.3 [k = 3] \\
\lambda''_{312} &: 0.097 [R_l^Z]. \\
\lambda''_{313} &: 0.097 [R_l^Z]. \\
\lambda''_{323} &: 0.097 [R_l^Z].
\end{aligned}$$

## 2.3 Scattering and decay processes

A multitude of bounds for the  $R_p$  coupling constants can be deduced from analyses of low and intermediate energy processes. To present the results available from the current literature, we shall organize the discussion according to the four main themes associated with violations of leptons and quark flavours and violations of leptonic and baryonic numbers.

### 2.3.1 Lepton flavour violation ( $\delta L = 0$ )

•• **Radiative decays of leptons.** The flavour non-diagonal, chirality-flip photon emission processes,  $l_J \rightarrow l_{J'} + \gamma(q)$ , [ $J \neq J'$ ], acquire  $R_p$  contributions at one-loop order from fermions-sfermions exchanges. The fit to experimental bounds leads to the bounds, [53, 54]:  $\lambda_{i1k}\lambda_{i2k} < 4.6 \cdot 10^{-4}\tilde{\nu}_{iL}^2$  or  $\tilde{e}_{kR}^2$ ,  $\lambda_{ij1}\lambda_{ij2} < 2.3 \cdot 10^{-4}\tilde{\nu}_{iL}^2$  or  $\tilde{e}_{jL}^2$ . The virtual (time-like) photon decay case, which is associated to the physical processes,  $l_J \rightarrow l_{J'} + e^+ + e^-$ , depends on vectorial type couplings in addition to the above tensorial couplings.

•• **Electric dipole moments (EDM).** In one-loop diagrams propagating sfermion-fermion internal lines and incorporating mass insertions for both fermions and sfermions lines, the  $R_p$  interactions can induce a contribution to the leptons EDM, where a CP-odd phase is introduced through the  $A$  soft supersymmetry parameter describing the  $\tilde{d}_L\tilde{d}_R$  mixing [55]. The strongest bounds, found by assuming a CP odd phase,  $\psi = \frac{\pi}{4}$ , are:  $\lambda'_{1jk} < 5 \cdot 10^{-5} - 10^{-6}$ ,  $\lambda'_{2jk} < 3 \cdot 10^{-1} - 10^{-2}$ . A contribution to the neutron EDM,  $d_n$ , [11] from the  $R_p$  interactions arises at two-loop order through  $W, \tilde{d}$  exchange. This involves a relative complex phase between  $R_p$  coupling constants described by the formula:  $Im(\lambda''_{32k}\lambda''_{12k}) = 10^{-5} \frac{d_n}{10^{-34}e \times cm} (\frac{m_{\tilde{d}}}{1TeV})^2$ .

•• **Anomalous magnetic dipole (M1) moments of leptons.** The discrepancies in the anomalous magnetic moments,  $a = g/2 - 1$ , of the electron and muon,  $\delta a_l = a_l^{exp} - a_l^{SM}$ , of Standard Model predictions (including higher loop orders of electroweak corrections and hadronic corrections) with respect to the measured values are determined with high precision. For the electron, the  $a_e$  observable serves mainly as a measurer of the hyperfine constant,  $\alpha$ . Still, in the comparison with other determinations of  $\alpha$ , there arises a finite discrepancy,  $\delta a_e \equiv a_e^{exp} - a_e^{SM} = 1 \cdot 10^{-11}$ , The discrepancy for the muon,  $\delta a_\mu = 11659230(84) \cdot 10^{-10} -$

$11659172(15.4) 10^{-10} < 2.6 10^{-8}$ , should serve as a sensitive test for new physics [56]. The  $R_p$  interactions contribute to the  $M1$  moments through the same type of one-loop diagrams as for the EDM. These contributions scale with the lepton mass as  $m_l$ . Related observables, which should be accessible at LEP, are the Z-boson current magnetic moment of the  $\tau$ -lepton or of heavy  $b$  or  $t$  quarks,  $a_{\tau,b}(m_Z^2)$ . These calculations are described by the same complex valued amplitude through an  $s - t$  crossing transformation.

•• **Charged leptons conversion.** The  $\mu^- \rightarrow e^-$  transition can be observed in the muonium -antimuonium atoms conversion process,  $M(\mu^- e^+) \rightarrow \bar{M}(\mu^+ e^-)$ . The associated bounds [25] read:  $\lambda_{231} \lambda_{132}^* < 6.3 10^{-3} \tilde{\nu}_{3L}^2$ . The other important atomic transition conversion process,  $\mu^- + {}^{45}\text{Ti} \rightarrow e^- + {}^{45}\text{Ti}$ , gives a strong bound on a rather peculiar linear combination of coupling constants [25],  $[\sum_k \lambda'_{2k1} \lambda'_{1k1} m_{\tilde{u}_{kL}}^{-2} - 2\lambda'_{k11} \lambda'_{k12} m_{\tilde{\nu}_{kL}}^{-2} \mp 2\lambda'_{k11} \lambda'_{k21} m_{\tilde{\nu}_{kL}}^{-2} - \frac{70}{14} \lambda'_{21k} \lambda'_{11k} m_{\tilde{d}_{kR}}^{-2}] < 1.6 10^{-11}$ .

### 2.3.2 Lepton number violation, ( $|\delta L| > 0$ )

•• **Three-body leptons decays.** The analysis of the flavour non-diagonal decay processes,  $l_m^\pm \rightarrow l_i^\pm + l_j^- + l_k^+$ , yields several bounds for pair products of coupling constants [23]. Among the strongest ones are,  $F_{1112}^2 + F_{2111}^2 < 4.3 10^{-13}$ ,  $[\mu \rightarrow 3e] F_{1113}^2 + F_{3111}^2 < 3.1 10^{-5}$ ,  $[\tau \rightarrow 3e]$ . If one excludes accidental cancellations these bounds on sums can be converted to equivalent bounds for fixed family indices [23].

•• **Neutrinos Majorana masses.** The general structure of the mass Lagrangian of charge neutral fermions allows  $\delta L = 2$  Majorana mass terms,  $\bar{\nu}_L A \nu_R^c + \bar{\nu}_L^c S \nu_R$ , along with the  $\delta L = 0$  Dirac mass terms,  $\bar{\nu}_L D \nu_R + \bar{\nu}_L^c D \nu_R^c$ . The  $R_p$  contributions may occur at one-loop level, via exchange of  $l - \tilde{l}_{kH}$ , with a mass insertion on fermions and a  $LR$  insertion on sfermions [12]. These yield:  $\delta m_{\nu_e} = \frac{\lambda'_{1jk}}{8\pi^2} \frac{M_{susy} m_{qj} m_{qk}}{m_{\tilde{q}}^2}$  [26]. Based on the empirical bound for the neutrino  $\nu_e$  mass,  $m_{\nu} < 5 eV$  as deduced from a fit to  $0\nu\beta\beta$  (neutrinoless double beta decay) data, one infers the bounds [26]:

$$\lambda'_{133} < 3.5 10^{-3} \left(\frac{m_{\tilde{q}}}{100 GeV}\right)^{\frac{1}{2}}, \quad \lambda'_{122} < 7. 10^{-2} \left(\frac{m_{\tilde{q}}}{100 GeV}\right)^{\frac{1}{2}}.$$

For the other coupling constants, especially those involving light families indices, such as,  $\lambda'_{111,112,121}$ , one obtains uninterestingly weak bounds. The neutrino mass bounds also imply bounds on the sneutrinos Majorana masses, which are defined as,  $L = -\frac{1}{2}(\tilde{m}_M^2 \tilde{\nu}_L \tilde{\nu}_L + h.c.)$  [39].

•• **Neutrinoless double beta decay.** The nuclear desintegration processes,  $(Z, N) \rightarrow (Z + 2, N - 2) + l_i^- + l_j^-$ , are measured through geochemical or laboratory experiments. The  ${}^{76}\text{Ge}$  target (of half-life  $T_{\frac{1}{2}} > 1.1 10^{25} yrs$ ) stands as one of the most favorite test case. A list of experimental data is provided in the review [57]. The tree level contributions from  $R$ -parity odd interactions can be described by Feynman diagrams where t-channel exchanged pairs of scalars,  $\tilde{e}_L$ ,  $e_L^*$  or  $\tilde{u}_L$ ,  $u_L^*$ , annihilate by emission of the final leptons pair via an intermediate neutralino or gluino t-channel exchange [27]. It can also be described by the reaction scheme,  $d + d \rightarrow \tilde{\chi}, \tilde{g} \rightarrow \tilde{d} + \tilde{d} \rightarrow (u + e) + (u + e)$ . The stringent bound deduced from this analysis is [27]:  $\lambda'_{111} / [(\frac{m_{\tilde{q}}}{100 GeV})^2 (\frac{m_{\tilde{q}}}{100 GeV})^{\frac{1}{2}}] < 3.3 \times 10^{-4}$ . An order of magnitude stronger bound, replacing the right hand side of the above inequality by  $3.2 10^{-5}$  was recently obtained in [59], using an analysis based on a gauge mediated supersymmetry breaking scenario.

Another class of contributions involves the t-channel exchange of a charged gauge boson  $W^\pm$  and a  $d$ -squark according to the reaction scheme,  $d + d \rightarrow u + W^- + d \rightarrow \nu \rightarrow u + e + \tilde{d} \rightarrow (u + e) + (u + e)$ , [28]. This mechanism requires an  $L - R$  mixing vertex for the produced down-squark,  $\tilde{b}_L - \tilde{b}_R$ . The strongest bounds occur for the following configurations of flavour indices (using the reference value  $\tilde{m} = 100 GeV$ ):

$\lambda'_{113} \lambda'_{131} < 7.9 \times 10^{-8}$ ,  $\lambda'_{112} \lambda'_{121} < 2.3 \times 10^{-6}$ ,  $\lambda'_{111} < 4.6 \times 10^{-5}$ , quoting from [29] where the initial analysis of [28] was updated.

### 2.3.3 Hadrons flavour violation

•• **Semi-leptonic decays of pseudoscalar mesons.** The decay process,  $K^+ \rightarrow \pi^+ + \nu + \bar{\nu}$ , is viewed as one of the the most favorite test case for new physics beyond the Standard Model [58]. The  $R_p$  interactions contribute at tree level by  $\tilde{d}_L$  and  $\tilde{d}_R$  exchange. Based on the experimental bound,  $BF_{exp} < 5.2 \times 10^{-9}$ , one deduces [20] the upper bounds,  $\lambda'_{imk} < 0.012 \tilde{d}_{kR}$ ,  $\lambda'_{i3k} < 0.52 \tilde{d}_{kR}$ . For the  $B$ - meson decay processes, one finds the bound:

$$\lambda'_{ijk} \lambda'_{[l3k, lj3]} < 1.1 10^{-3} \tilde{d}_{k[R,L]}^2, \quad [B \rightarrow X_q + \nu + \bar{\nu}] \quad [50].$$

•• **Mixing of light and heavy quarks neutral mesons.** In the single dominant  $R_p$  coupling constant hypothesis [20], the one-loop box diagrams, involving internal sfermions and fermions lines, can contribute to

the transition matrix elements of neutral mesons charge conjugate pairs,  $K - \bar{K}$ ,  $D - \bar{D}$ ,  $B - \bar{B}$  [11]. The deduced bounds, involving the multiplicative mass scaling dependence,  $[(\frac{100GeV}{m_{\nu_i L}^2})^2 + (\frac{100GeV}{m_{\tilde{d}_{kR}}^2})^2]^{-1/4}$ , are [20]:

$$\lambda'_{imk} < 0.11, [K\bar{K}]; \lambda'_{ijk} < 0.16, [D\bar{D}], \lambda'_{i3k} < 1.1, [B\bar{B}],$$

Under the hypothesis of two dominant  $\mathcal{R}_p$  coupling constants [23], tree level contributions can occur via scalar exchange diagrams. The four-fermion couplings are then controlled by the quadratic products,  $F_{abcd}$ , where the various entries span the sets:  $(ab) = [13, 23, 31, 32]$ ,  $(cd) = [11, 12, 21, 22]$ . Some of the strongest bounds are [23, 60]:

$$F'_{1311} < 2 \cdot 10^{-5}, F'_{1331} < 3.3 \cdot 10^{-8}, F'_{1221} < 4.5 \cdot 10^{-9}.$$

The CP violation asymmetries in the  $B^-$  mesons decays, say, to CP-eigenstates,

$$a_{f(CP)} = \frac{\Gamma(B^0(t) \rightarrow f(CP)) - \Gamma(\bar{B}^0(t) \rightarrow f(CP))}{\Gamma(B^0(t) \rightarrow f(CP)) + \Gamma(\bar{B}^0(t) \rightarrow f(CP))} = \frac{(1 - |r_{f(CP)}|^2) \cos \Delta mt - 2 \text{Im} r_{f(CP)} \sin \Delta mt}{(1 + |r_{f(CP)}|^2)},$$

are controlled by the ratio of amplitudes,  $r_{f(CP)} = qA(\bar{B} \rightarrow f(CP))/(pA(B \rightarrow f(CP)))$ , where the ratio of  $B - \bar{B}$  mixing parameters is numerically,  $q/p \approx 1$ . The tree level  $\mathcal{R}_p$  interactions to the b-quarks decay subprocesses,  $\bar{b} \rightarrow \bar{c}\bar{c}\bar{d}_i$ ,  $\bar{c}u_i\bar{d}$ ,  $\dots$ , can lead to significant contributions to  $r_{f(CP)}$ , [60]. In particular, these could contribute to subprocesses such as,  $\bar{b} \rightarrow \bar{d}_i d \bar{d}_i$ ,  $[i = 1, 2, 3]$ , inducing decay channels such as,  $B \rightarrow K^0 \bar{K}^0$ ,  $\phi\pi^0$ , which are tree level forbidden in the standard model.

•• **Non-leptonic decays of heavy quarks mesons.** To the flavour changing rare decay processes,  $B^+ \rightarrow \bar{K}^0 + K^+$  and their charge conjugate partners, are assigned the experimental upper bounds,  $BF < 5 \cdot 10^{-5}$ . Fitting these with the  $\mathcal{R}_p$  contributions provides the bounds [31]:  $\lambda''_{i32}\lambda''_{i21} < 5 \cdot 10^{-3}(\frac{m_{\tilde{q}}}{m_W})^2$ . The BF,  $\Gamma(B^+ \rightarrow \bar{K}^0 + \pi^+)/\Gamma(B^+ \rightarrow J/\psi + K^+)$ , implies  $\lambda''_{i31}\lambda''_{i21} < 4.1 \cdot 10^{-3}(\frac{m_{\tilde{q}}}{m_W})^2$ .

•• **Top-quark decay channels.** The  $\mathcal{R}_p$  induced two-body decay channels,  $t \rightarrow \tilde{l}_i^+ + \tilde{d}_k$ , if kinematically allowed, can compete with the electroweak decay channels,  $t \rightarrow b + W^+$ . In reference to the weak interaction decay channel, the decay schemes,  $\tilde{l}^+ \rightarrow \tilde{\chi}^0 + l$ ,  $\tilde{\chi}^0 \rightarrow \nu_i + b + \tilde{d}_k$  cause violation of  $e - \mu$  universality and a surplus of  $b$ -quarks events through the interactions,  $\lambda'_{i3k}$ . This possibility can be probed on  $p + \bar{p} \rightarrow t + \bar{t}$  production events recorded at the Tevatron, by comparison of final states having  $e$  or  $\mu$  accompanied by hadronic jets. Fitting the  $\mathcal{R}_p$  contributions to the ratio of single  $e$  to  $\mu$  BFs to the ratio determined from the CDF Collaboration top-quark-antiquark production events, yields the bounds, [20]  $\lambda'_{13k} < 0.41$ .

### 2.3.4 Baryon number violation

•• **Proton decay channels**,  $\delta B = 1, \delta L = \pm 1$ . The effective Lagrangian description of the elementary baryons decays involves dimension-6 operators built with quarks and lepton fields. The  $\mathcal{R}_p$  interactions can induce  $B - L$  conserving contributions to the two decay processes,  $P \rightarrow \pi^0 + e^+$  and  $\pi^+ + \bar{\nu}$ , through tree level  $\tilde{d}_{kR}$  squarks s-channel exchange. Also at tree level, there can occur  $B + L$  conserving interactions, through the insertion of mass mixing terms coupling the left and right chirality squarks. These contribute to the chirality-flip,  $\delta B = -\delta L = 1$ , decay process,  $P \rightarrow \pi^+ + \nu$ . Borrowing the familiar dimensional analysis argument from GUT physics, [61, 62, 2], one derives, based on the naive rescaling,  $m_{\tilde{\chi}}^2 \rightarrow \tilde{m}^2/\lambda''\lambda'$ , the bounds,  $\lambda'_{11k}\lambda''_{11k} < 10^{-25} - 10^{-27} \tilde{d}_{kR}^2$  for the first two processes,  $P \rightarrow \pi^0 + e^+$ ,  $\pi^+ + \bar{\nu}$  and  $\lambda'_{11k}\lambda''_{m1k} < 10^{-25} - 10^{-27} \tilde{d}_{kR}^2(\frac{m_{\tilde{d}_{kR}}^2}{\delta m_{LR}^2})$ , for the third process ( $P \rightarrow \pi^+ + \nu$ ).

The analysis of vertex loop diagrams associated with the Higgs boson dressing of the vertex  $\tilde{d}ud$  and the box loop diagrams,  $u + d \rightarrow h^+ \rightarrow d + u \rightarrow \tilde{d} \rightarrow \bar{\nu} + d$ , having the same configurations of external lines as for tree level diagrams, and propagating charged and neutral Higgs bosons internal lines [30], indicates that these could provide competitive bounds on the  $\mathcal{R}_p$  coupling constants. This gives strong bounds for all combinations of pair products,  $\lambda'\lambda'' < 10^{-7} - 10^{-9}$ . Stronger bounds,  $\lambda'\lambda'' < 10^{-11}$ , hold if ones takes CKM flavour mixing into account. Some representative examples are:  $\lambda'_{3j3}\lambda''_{121} < 10^{-7}$ , (no matching case)  $\lambda'_{2j2}\lambda''_{131} < 10^{-9}$  (matching case), where matching (no matching) refers to the case in which the generation index of  $d$  or  $d^c$  fields in  $\lambda'$  coincides (differs) from that of the  $d^c$  field in  $\lambda''$ .

Another mechanism for proton decay, involving a sequential tree level exchange of  $\tilde{b}$ ,  $\tilde{\chi}^\pm$ , [31] gives bounds for the following three product combinations,

$$\lambda'_{ijk}\lambda''_{m21} < 10^{-9}, \lambda'_{ijk}\lambda''_{m31} < 10^{-9}, \lambda'_{ijk}\lambda''_{m32} < 10^{-9}.$$

However, there remains in this analysis certain weakly constrained products, such as,

$$\lambda'_{12m}\lambda''_{33m} < 10^{-2}, \lambda'_{112}\lambda''_{331} < 10^{-2}, \lambda'_{33l}\lambda''_{221} < 10^{-1}.$$

The contributions to the  $\delta B = 2$  B-meson decay processes,  $B \rightarrow \Lambda + \Lambda$  or  $B \rightarrow \Sigma^+ + \Sigma^-$ , at tree level with sequential  $\tilde{q}$  and  $\tilde{\chi}^+$  exchanges [31], give bounds on several products,

$$\lambda_{ijk}\lambda''_{131} < 10^{-13}, \lambda_{ijk}\lambda''_{132} < 10^{-12}, \lambda_{ijk}\lambda''_{221} < 10^{-13}, \lambda_{ijk}\lambda''_{321} < 10^{-13}.$$

There remain, however, certain weakly constrained products, such as,  $\lambda_{ijk}\lambda''_{33[m=1,2]} < 10^{-3}, 10^{-2}, \lambda_{ijk}\lambda''_{23[m=1,2]} < 10^{-3}, 10^{-2}$ .

•• **Decays of scalar and neutralino LSPs (Lightest Supersymmetric Particles).** The  $\mathcal{R}_p$  interactions can contribute at tree level to desintegrations of scalar neutrinos,  $\tilde{f} \rightarrow f' + \nu$ , or of neutralinos,  $\tilde{\chi}^0 \rightarrow f + f' + \nu$ . In order for these processes to occur inside a detector of length  $l > 1$  meter, (corresponding to proper lifetimes above  $3 \cdot 10^{-9}$ s) based on the tree-level decay mechanisms, one must require the lower bounds on coupling constants [10, 14],

$$[\sqrt{3}\lambda', \lambda]_{sneutrinos} > \frac{10^{-7}\sqrt{\beta\gamma}}{(\tilde{m}/GeV)^{\frac{1}{2}}}, \quad [\sqrt{3}\lambda'', \sqrt{3}\lambda', \lambda]_{gauginos} > 5 \cdot 10^{-2}\sqrt{\beta\gamma}\left(\frac{m_{\tilde{f}}}{100GeV}\right)^2\left(\frac{1GeV}{m_{\tilde{\chi}}}\right)^{5/2},$$

where  $\beta = v/c$  is the decaying particle velocity, and  $\gamma = (1 - \beta^2)^{-\frac{1}{2}}$ .

The stability conditions of sneutrinos or neutralinos against decays occurring within the age of the Universe today,  $\tau_U \approx 10^9$  yrs, would place bounds on all the coupling constants  $\lambda, \lambda', \lambda''$ , which are smaller than the detectors bounds given above by a factor of  $10^{12}$ . One concludes from this that cold dark matter candidates from supersymmetry are practically dismissed, unless  $R$ -parity is broken at infinitesimal levels.

The one-loop level decay modes,  $\tilde{\chi}^0 \rightarrow \nu + X, \gamma + X$ , place bounds on products of  $\lambda$  with the sneutrino VEVs  $v_i$  [63]. Weaker bounds on the  $\mathcal{R}_p$  coupling constants would be imposed if one allowed the LSPs to start decaying after the nucleosynthesis period or after the protons and electrons-positrons recombination period. The cosmological bounds on the LSPs masses obtained from the familiar constraints on the age of the Universe and the energy density abundance,  $\Omega_0 h^2 < 1$ , depend principally on the LSPs annihilation rates. These are practically unaffected by the  $\mathcal{R}_p$  interactions except for the implications derived from the effects of the LSPs decays following their thermal decoupling from the plasma. The physics here is similar to that of heavy neutrinos [64].

•• **Cosmological baryon and lepton number asymmetries.** The phenomenology of baryogenesis (ratio of baryon number to entropy densities of the Universe set today at the small value,  $B = n_B/s \approx 10^{-10}$ ) faces three basic problems [64]: (i) Generation of a baryon asymmetry at some temperature,  $T_{BA}$ . Minds are still unsettled concerning the relevant mechanism and the scale of  $T_{BA}$ , for which a variety of possibilities are still envisaged (high energy GUTs,  $T_{BA} \approx m_X/10$ ; low energy Standard Model,  $T_{BA} \approx T_C = m_W/\alpha_W$ ; or intermediate non-perturbative approach as in the Dine-Affleck squarks condensate mechanism). (ii) Erasure of the preexisting baryon asymmetry via B and/or L violating interactions inducing reactions among quarks and leptons or gauge and Higgs bosons, which might be in thermal equilibrium at some temperature,  $T < T_{BA}$  during the cosmic expansion. This is formulated in terms of the reaction rate  $\Gamma_D$  and the Universe expansion rate,  $H \approx 20T^2/M_P$ , by the out-of-equilibrium condition,  $\Gamma_D/H < 1$ . The erasure takes place for all linear combinations,  $B + aL$ , except for the (non-thermalizing modes) which remain conserved by the interactions. (iii) The non-perturbative contributions associated to the electroweak sphalerons, which induce vacuum transition processes,  $0 \rightarrow \prod_i (u_{iL}u_{iL}d_{iL}l_{iL}^-)$ ,  $0 \rightarrow \prod_i (u_{iL}d_{iL}d_{iL}l_{iL})$ , violating  $B, L$  via the anomalous combination,  $\delta(B + L) = 2N_{gen}$ , while conserving  $B_i - L_i$ ,  $[i = 1, 2, 3]$ . Accounting for the flavour changing interactions of quarks, the effectively conserved combinations are in fact,  $(B/3 - L_i)$ . Since the sphaleron induced rates, over the wide period,  $m_X < T < T_C$ , are very much faster than the expansion rate,  $\Gamma_{sphal}/H \approx (T/H)e^{-2m_W/(2\alpha_W T)} \approx 10^{17}$ , this will damp the  $(B+L)$  component of the asymmetry, while leaving the components  $(B/3 - L_i)$  constant. A necessary condition for baryon asymmetry erasure in the presence of sphalerons is then that this must have been produced via  $(B - L)$  or  $(B - L_i)$  (for some fixed  $i$ ) violating interactions [65, 66].

The out-of-equilibrium conditions, taking into account the set of  $2 \rightarrow 2$  processes,  $u + d \rightarrow \tilde{d}^* \rightarrow \bar{d} + \tilde{\chi}^0$ ,  $u + e \rightarrow \tilde{d} \rightarrow d + \tilde{\chi}^0$ ,  $\nu + e \rightarrow \tilde{\mu} \rightarrow \mu + \tilde{\chi}^0$ , and  $2 \rightarrow 1$  processes,  $d + \nu \rightarrow \tilde{d}, u + e \rightarrow \tilde{d}, \nu + e \rightarrow \tilde{\mu}$ , give on all  $\mathcal{R}_p$  coupling constants the strong bounds,  $\lambda, \lambda', \lambda'' < 5 \times 10^{-7} \left(\frac{\tilde{m}}{1TeV}\right)^{\frac{1}{2}}$ , corresponding to an updated version [67] of previous analyses [63, 65].

A more refined analysis in [67], accounting for all the relevant symmetries of the Standard Model, through the equations on the particles chemical potentials expressing chemical equilibrium constraints, turns out to lead to milder constraints. Thus, it is found that the bounds on the B-violating  $\lambda''$  interactions are removed in the absence of sphalerons, but remain in force when these are included. For the L-violating interactions, only a subset of the coupling constants,  $\lambda, \lambda'$ , remains bounded. The reason is that one need impose the out-of-equilibrium conditions only for one lepton family, say  $J$ , corresponding to one conserved combination,  $(B/3 - L_J)$ . The above bounds would then hold only for the subsets,  $\lambda_{Jjk}, \lambda'_{Jjk}$ . An indicative analysis of the fields basis dependence of these bounds is made in [21].

For the dimension  $D > 5$  non-renormalizable operators, the out-of-equilibrium conditions, as formulated by the inequalities:  $\Gamma_D \approx T(\frac{T}{\Lambda})^{2(D-4)} < H \approx \frac{20T^2}{M_P}$ , lead to the bounds:  $\Lambda > [\frac{T^{2(D-4)-1}M_P}{20}]^{1/2(D-4)}$  [65]. The strongest bound, associated with  $T = T_{GUT} \approx 10^{14}$  GeV, is:  $\Lambda > 10^{14+2/(D-4)}$  GeV.

It is important, however, to note that these baryogenesis erasure constraints are really sufficient conditions and do not constitute strict bounds. They could be evaded if baryogenesis occurred at the electroweak scale or in non-perturbative models in case of an insufficient reheat temperature.

•• **Nucleon-antinucleon oscillations.** The  $N \rightarrow \bar{N}$  transition is described by the effective Lagrangian,  $L = \delta m \bar{N}^c N + h.c.$ , such that the oscillation time for free neutrons reads,  $\tau_{oscill}^{-1} = \Gamma = 1/\delta m$ . Recall [62] that this is linked to the nuclear lifetime against decays,  $NN \rightarrow X$ , denoted as,  $\tau_{NN}$ , by the relationship:  $\tau_{NN} = a\delta m^2/m_N$ , where  $a \approx 10^{-2}$  is a nuclear wave function factor and  $m_N$  the nucleon mass. The present experimental bound on oscillation time is,  $\tau_{oscill} > 1.2 \cdot 10^8$  s. This is to be compared with the bound deduced from,  $\tau_{NN} > 10^{32}$  years, which yields:  $\delta m < 10^{-28}$ , hence  $\tau_{oscill} > 10^6$  s.

The initially proposed  $/R_p$  induced mechanism [5] involved an intermediate three-scalars annihilation coupling. A more competitive mechanisms has been proposed which involve the three-body mechanism,  $udd_R \rightarrow \tilde{d}_R + d_R \rightarrow \tilde{g} \rightarrow d^c \tilde{d}_R' \rightarrow d^c u^c d^c$ . For a simple estimate, one can borrow the result from GUT physics,  $L = e^4 O/M^5$ , with  $M = 4 \cdot 10^5 - 10^6$  GeV. The bound resulting from an analysis of the oscillation amplitude reads,  $\lambda''_{112} < 3.3 \cdot 10^{-10} - 10^{-11}$  [5].

Another three-body mechanism uses the reactions scheme,  $udd_R \rightarrow \tilde{d}_R + d_R \rightarrow \tilde{d}_L' + d_R \rightarrow q\tilde{q} \rightarrow d^c \tilde{d}_R'' \rightarrow d^c u^c d^c$ , which involves a  $W^\pm$  gauge boson box diagram [32]. This is described by the Lagrangian,  $L_{\tilde{w}} \propto Col(\bar{u}^c d)(\bar{d}^c d)(\bar{u}^c d)$ , where  $Col$  stands for a color factor. The resulting bound is:  $\lambda''_{132} < 10^{-3}$  [32].

•• **Double nucleon decay processes,  $\delta B = 2$ .** The nuclear decay processes,  $^{16}O \rightarrow ^{14}C + 2\pi^0, + \dots$ , are described by dimension-9 six-fermion operators,  $O = d_R d_R d_R u_R q_L q_L, d_R d_R q_L q_L q_L q_L, \dots$ . Using a naive rescaling from the GUT-like Lagrangian,  $L = \frac{e^4}{M^5} O$ , the associated inverse lifetime formula reads,  $(\tau/yrs)^{-1} \approx \frac{e^8 10^{29}}{(M/GeV)^{10}}$  where,  $e = (4\pi\alpha)^{\frac{1}{2}} \approx 0.3$ , is the electron charge in Heaviside units. From the experimental bound,  $\tau > 10^{30,33}$  yrs, one deduces the bounds:  $\lambda''_{131} < 5 \cdot 10^{-3}$ ,  $\lambda''_{121} < 10^{-6}$  [5]. The peculiar double nucleon,  $\delta B = \delta S = -2$ , decay process,  $N + N \rightarrow ^{14}C + K^+ + K^+$  could provide a competitive channel for nuclear decay reactions. The analysis in [32] gives the bound,  $\lambda''_{121} < 10^{-15} \mathcal{R}^{-5/2}$ , where the parameter  $\tilde{\Lambda}$  in  $\mathcal{R} = \frac{\tilde{\Lambda}}{(m_{\tilde{g}} m_q^2)^{1/5}}$ , represents an estimate for the nuclear matrix element. Varying  $\mathcal{R}$  in the interval,  $10^{-3} - 10^{-6}$ , one finds:  $\lambda''_{121} < 10^{-7} - 10^0$ .

•• **Dimension-5 operators contributions to proton decay.** Except for few isolated works, little attention was devoted so far to the dimension-5 dangerous operators. The analysis in [68] has focussed on the baryon number violating F-term operator,  $(QQQL)_F$ , which can be induced by tree level exchange of a massive color triplet Higgs bosons. This superpotential term contributes two-fermions two scalars interactions, which induce via a one-loop gaugino dressing mechanism [69, 70, 71] contributions described by dimension-6 four-fermion operators,  $qqqq$ . There arise a set of several such operators,  $O_{ni}$ , which could cause proton or neutron decays in peculiar channels, such as  $P \rightarrow K^0 + l_i^+$ ,  $N \rightarrow K^0 + \bar{\nu}_i$ . Restricting to the dominant contribution from wino dressing, one deduces the effective Lagrangian as,  $L = \frac{g^2}{4\pi^2} \sum_{n,i} \frac{g_{1i}}{\Lambda} a_{ni} O_{ni} + \frac{g_{2i}}{\Lambda} b_{ni} O_{ni}$ , where  $a_{ni}, b_{ni}$  are calculable loop amplitudes factors,  $n$  labels the independent operators and  $i$  the emitted leptons flavour. The experimental bounds, based on the choice of gravitational Planck mass scale,  $\Lambda = M^* = M_P/\sqrt{8\pi}$ , yield:  $(\sum_i |g_{[1,2]i}|^2)^{\frac{1}{2}} < [3.6 \cdot 10^{-8}, 1.0 \cdot 10^{-7}]$ .

•• **Infrared fixed points.** In direct analogy with the familiar estimate for the top-quark mass,  $m_t(pole) \equiv (200GeV) \sin \beta$ , which is derived by assuming the existence of an infrared fixed point in the Yukawa coupling constant,  $\lambda_{33}^u$ , one can deduce similar fixed point bounds for the third generation  $/R_p$  coupling constants. The argument is again based on the vanishing of the beta function in the renormalization group flow, via the competition between Yukawa and gauge interactions, as displayed schematically by the equation,  $(4\pi)^2 \frac{\partial \ln \lambda_{ijk}}{\partial t} = \frac{8}{5} g_1^2 + 3g_2^2 - (\delta_{j3} + 2\delta_{k3}) \lambda_{33}^{u2}$ ,  $[t = \ln m_X^2/Q^2]$ , where the c-number coefficients in front of the coupling constants represent the fields anomalous dimensions. Equivalently, this reflects on the assumption of perturbative unitarity (absence of Landau poles) for the  $R_p$  coupling constants at high energies scales. The predicted fixed point bounds [72, 32, 73, 74] are:  $\lambda_{233} < 0.90$ ,  $\lambda'_{333} < 1.01$ ,  $\lambda''_{323} < 1.02$ .

## 2.4 Conclusions

The  $R_p$  interactions represent one among several sources of physics beyond the Standard Model. Other possibilities in the context of non-minimal supersymmetry (leptoquarks, fourth family of quarks and leptons, left



right symmetric gauge groups, mirror fermions, extra gauge bosons, etc...) may be realized. It is likely, however, as has been assumed, that one can exclude interference effects between these various possibilities.

It is clear that the low energy phenomenology is a rich and valuable source of information on the  $\mathcal{R}_p$  interactions. Perhaps the strongest and most robust bounds are those derived from the rare forbidden neutrinoless double beta decay, proton decay and  $l \rightarrow eee$  decay processes. Some general trends here are that: (1) Most of the B-violating coupling constants  $\lambda''_{ijk}$  are below  $10^{-6}$  or so, except for  $\lambda''_{332}$ ; (2) The L-violating coupling constants,  $\lambda_{lmn}$ ,  $\lambda'_{lmn}$ , associated with the first and second families and also those involving one third family index only, such as,  $\lambda_{3mm}$ ,  $\lambda'_{3mn}$ , and permutations thereof, tend to be more suppressed. There still survives a number of weakly constrained cases in the specific family configurations,  $\lambda_{123}$ ,  $\lambda_{l33}$ ;  $\lambda'_{i13}$ ,  $\lambda'_{i23}$ , etc... This nourishes the (foolish?) hope that a few coupling constants may just happen to be of order  $10^{-1}$  or so, enough to lead to directly observable effects at high energy colliders.

Nevertheless, one must exercise a critical eye on the model dependent assumptions and not treat all bounds indiscriminately. The apparently strong bounds deduced from the leptons EDMs, the two-nucleon decay processes or the cosmic baryon asymmetry erasure appear as fragile bounds relying on model-dependent assumptions. One must also keep in mind the limitations in the basic hypotheses of single or pairs of dominant coupling constants. These presume the absence of cancellations from different configurations and the existence of strong flavour hierarchies. Often this is taken as a reflection of dynamics associated with horizontal flavour symmetries. However, to satisfy the various constraints imposed on supersymmetry models, it is possible that Nature may have chosen a different option. This could be string theory or gauge dynamics. It could also be along the lines of the so-called effective supersymmetry approach [75], implying TeV scale supersymmetry breaking parameters with lightest scalar superpartners to be found amongst the third family quarks or leptons.

The prospects on the long term are encouraging. Thanks to the planned machines, experimental measurements of rare forbidden decay processes are expected to gain several order of magnitude in sensitivities [56]. Factors of 10 – 100 improvements in accuracies are also anticipated for high precision measurements of magnetic or electric dipole moments. Some progress, although at a more modest level, is expected to take place for the high precision physics observables. Our theoretical understanding of supersymmetry and of physics beyond the standard model is likely also to deepen in the meantime. Efforts on all these fronts should be needed in meeting with the future challenges of high precision physics.

### 3 Alternatives to conserved $R$ -parity

On the theoretical side, one has a priori little knowledge on  $R$ -parity violating couplings, since they have the same structure as Yukawa couplings, which are not constrained by the symmetries of the MSSM. Turning the argument the other way, one expects any model of fermion masses to give predictions for broken  $R$ -parity [77, 78, 79, 80, 81, 82]. In this note<sup>2</sup>, we want to show that abelian family symmetries, which can explain the observed fermion mass spectrum, naturally generate a flavour hierarchy between  $R$ -parity violating couplings that can easily satisfy all present experimental bounds.

Let us first explain how a family-dependent symmetry  $U(1)_X$  constrains the Yukawa sector [83]. Consider a Yukawa coupling  $Q_i \bar{u}_j H_u$ ; invariance under  $U(1)_X$  implies that  $Q_i \bar{u}_j H_u$  appears in the superpotential only if its  $X$ -charge vanishes, i.e.  $q_i + u_j + h_u = 0$  (we denote generically the charge of any superfield  $\Phi_i$  by a small letter  $\phi_i$ ). To account for the large top quark mass, we shall assume that this happens only for the Yukawa coupling  $Q_3 \bar{u}_3 H_u$ ; thus all fermions but the top quark are massless before the breaking of the symmetry. One further assumes that the family symmetry is broken by the vacuum expectation value of a Standard Model singlet  $\theta$  with  $X$ -charge  $-1$ , and that the other Yukawa couplings are generated from interactions of the form

$$y_{ij}^u Q_i \bar{u}_j H_u \left( \frac{\theta}{M} \right)^{q_i + u_j + h_u} \quad (16)$$

where  $M$  is a mass scale, and  $y_{ij}^u$  is an unconstrained coupling of order one. Such nonrenormalizable terms typically appear in the low-energy effective field theory of a fundamental theory with heavy fermions of mass  $M$  - one may also think of a string theory, in which case  $M = M_{Pl}$ . If  $U(1)_X$  is broken below the scale  $M$ ,  $\epsilon = \langle \theta \rangle / M$  is a small parameter, and (16) generates an effective Yukawa coupling

$$Y_{ij}^u = y_{ij}^u \epsilon^{q_i + u_j + h_u} \quad (17)$$

whose order of magnitude is fixed by the  $X$ -charges. Similarly, one has, for down quarks and charged leptons:

$$Y_{ij}^d \sim \epsilon^{q_i + d_j + h_d} \quad (18)$$

$$Y_{ij}^e \sim \epsilon^{l_i + e_j + h_d} \quad (19)$$

A family-dependent symmetry thus naturally yields a hierarchy between Yukawa couplings. Notice that if a particular coupling  $Y_{ij}^u$  has a negative charge,  $q_i + u_j + h_u < 0$ , it is not possible to generate it from (16), due to the property of holomorphicity of the superpotential  $W$ .

An explicit example of a model which reproduces the observed masses of quarks and their mixing angles is the following. Consider the charge assignment

$$\begin{aligned} q_1 - q_3 = 3, \quad q_2 - q_3 = 2, \quad u_1 - u_3 = 5, \quad u_2 - u_3 = 2, \\ d_1 - d_3 = 1, \quad d_2 - d_3 = 0. \end{aligned} \quad (20)$$

The corresponding quark mass matrices are of the form

$$Y^u = \begin{pmatrix} \epsilon^8 & \epsilon^5 & \epsilon^3 \\ \epsilon^7 & \epsilon^4 & \epsilon^2 \\ \epsilon^5 & \epsilon^2 & 1 \end{pmatrix} \quad Y^d = \epsilon^x \begin{pmatrix} \epsilon^4 & \epsilon^3 & \epsilon^3 \\ \epsilon^3 & \epsilon^2 & \epsilon^2 \\ \epsilon & 1 & 1 \end{pmatrix} \quad (21)$$

where in fact all entries are only known up to factors of order one. The small number  $\epsilon$  has been assumed here to be numerically equal to the Cabibbo angle,  $V_{us} \simeq 0.22$ . The assignment above gives the following relations

$$\begin{aligned} \frac{m_u}{m_t} \sim \epsilon^8, \quad \frac{m_c}{m_t} \sim \epsilon^4, \quad \frac{m_d}{m_b} \sim \epsilon^4, \quad \frac{m_s}{m_b} \sim \epsilon^2, \\ V_{us} \sim V_{cd} \sim \epsilon, \quad V_{ub} \sim V_{td} \sim \epsilon^3, \quad V_{cb} \sim V_{ts} \sim \epsilon^2, \\ \frac{m_b}{m_t} \sim \epsilon^x \frac{1}{\tan \beta}, \end{aligned} \quad (22)$$

which hold at the scale where the abelian symmetry is broken, usually taken to be close to the Planck scale. With renormalization group effects down to the weak scale taken into account, this charge assignment can

<sup>2</sup>Most of what follows is based on work done in collaboration with P. Binétruy and C.A. Savoy [81].

accommodate the observed masses and mixings. More generally, assuming that the charge carried by each Yukawa coupling is positive, there are only a few structures for  $Y^u$  and  $Y^d$  allowed by the data, which differ from (21) only by a  $\pm 1$  change in the powers of  $\epsilon$ . In the lepton sector there is more freedom, as the leptonic mixing angles (which are physical only if the neutrinos are massive) are not yet measured. The number  $x = q_3 + d_3 + h_d$ , which is related through (22) to the value of  $\tan\beta$ , is actually constrained if one imposes gauge anomaly cancellation conditions.

$R$ -parity violating couplings are constrained by  $U(1)_X$  exactly in the same way as Yukawa couplings. They are generated from the following nonrenormalizable interactions:

$$L_i L_j \bar{e}_k \left( \frac{\theta}{M} \right)^{l_i + l_j + e_k}, \quad L_i Q_j \bar{d}_k \left( \frac{\theta}{M} \right)^{l_i + q_j + d_k} \quad (23)$$

To avoid unnaturally large values of the quark charges, we have assumed a baryon parity that forbids the appearance of  $\bar{u}d\bar{d}$  terms in the superpotential<sup>3</sup>, thus preventing proton decay. One can see from (23) that abelian family symmetries yield a hierarchy between  $R$ -parity violating couplings that mimics (in order of magnitude) the down quark and charged lepton mass hierarchies. Indeed, one has [81]:

$$\lambda_{ijk} \sim \epsilon^{l_i - h_d} Y_{jk}^e \quad (24)$$

$$\lambda'_{ijk} \sim \epsilon^{l_i - h_d} Y_{jk}^d \quad (25)$$

Provided that the Yukawa matrices  $Y^d$  and  $Y^e$  are known, experimental limits on  $\lambda$  and  $\lambda'$  can be translated into a constraint on  $l_i - h_d$ . We shall assume here that the charge carried by each operator is positive, and take for  $Y^d$  the structure (21). In the lepton sector, there is not enough data to determine completely the  $Y_{ij}^e$ ; however, it is possible to derive upper bounds on the couplings (24) from the three charged lepton masses. Assuming a small value of  $\tan\beta$  (corresponding to  $x = 3$ ), one finds that the experimental bounds on product couplings including [28, 23, 36]

$$\text{Im}(\lambda'_{i12} \lambda_{i21}^*) \leq 8.10^{-12} \quad (\epsilon_K) \quad (26)$$

$$(27)$$

are satisfied as soon as:

$$l_i - h_d \geq 2 - 3 \quad (28)$$

For moderate or large values of  $\tan\beta$ , larger charges would be required.

Now the condition (28) can be used, together with (24) and (25), to derive upper bounds<sup>4</sup> on the individual couplings  $\lambda$  and  $\lambda'$ . We find that all of them are (well) below the experimental limits - in particular, there is no explanation of the possible HERA large- $Q^2$  anomaly. Thus, if abelian family symmetries are responsible for the observed fermion mass spectrum, we expect the first signals for broken  $R$ -parity to come from FCNC processes. Let us stress, however, that these conclusions are not completely generic for abelian family symmetries: they would be modified if  $U(1)_X$  were broken by a vector-like pair of singlets [82], or if we gave up the assumption that the  $X$ -charge carried by each operator is positive.

In addition, the inclusion of the bilinear  $R$ -parity violating terms  $\mu_i L_i H_u$  can modify the previous picture. In the presence of these terms, the  $L_i$  fields assume a vacuum expectation value together with the Higgs fields. The low-energy  $H_d$  and  $L_i$  fields have then to be redefined in such a way that only  $H_d$  has a nonzero vev. This may modify significantly the order of magnitude relations (24) and (25), as we show below. For convenience, we write the superpotential as

$$W = \lambda_{\alpha\beta k}^e \hat{L}_\alpha \hat{L}_\beta \bar{e}_k + \lambda_{\alpha j k}^d \hat{L}_\alpha Q_j \bar{d}_k + \mu_\alpha \hat{L}_\alpha H_u \quad (29)$$

where  $\hat{L}_\alpha$ ,  $\alpha = 0, 1, 2, 3$  denote four  $SU(2)_L$  doublets with hypercharge  $Y = -1$  and well-defined  $X$ -charges  $l_\alpha$ . After supersymmetry breaking, each  $\hat{L}_\alpha$  acquires a vev,  $v_\alpha \equiv \langle L_\alpha^0 \rangle$ . The standard Higgs field  $H_d$  is defined

<sup>3</sup>This baryon parity can be a residual discrete symmetry resulting from the breaking of  $U(1)_X$ . Another possibility is that the couplings are forbidden by holomorphy, which happens when all combinations of charges  $u_i + d_j + d_k$ ,  $i, j, k = 1, 2, 3$ , are negative [81].

<sup>4</sup>It should be stressed here that, while (28) strongly depends on  $\tan\beta$ , this is not the case for the couplings  $\lambda$  and  $\lambda'$  themselves.

as the combination of the  $\hat{L}_\alpha$  whose vev breaks the hypercharge:

$$H_d = \frac{1}{v_d} \sum_\alpha v_\alpha \hat{L}_\alpha \quad (30)$$

where  $v_d \equiv (\sum_\alpha v_\alpha^2)^{1/2}$ . The orthogonal combinations  $L_i$ ,  $i = 1, 2, 3$  are the usual lepton fields:

$$\hat{L}_\alpha = \frac{v_\alpha}{v_d} H_d + \sum_i e_{\alpha i} L_i \quad (31)$$

The ambiguity in the rotation  $e_{\alpha i}$  is partially lifted by requiring that  $L_1$  and  $L_2$  do not couple to  $H_u$ . After this redefinition, the superpotential reads:

$$W = Y_{ik}^e L_i \bar{e}_k H_d + Y_{ik}^d Q_i \bar{d}_k H_d + \lambda_{ijk} L_i L_j \bar{e}_k + \lambda'_{ijk} L_i Q_j \bar{d}_k + \mu \cos \xi H_d H_u + \mu \sin \xi L_3 H_u \quad (32)$$

where  $\mu \equiv (\sum_\alpha \mu_\alpha^2)^{1/2}$ ,  $\xi$  is the angle between the vectors  $\vec{\mu}$  and  $\vec{v}$ ,  $\cos \xi \equiv \sum_\alpha \mu_\alpha v_\alpha / \mu v_d$ , and the physical Yukawa and  $R$ -parity violating couplings are given by:

$$Y_{ik}^e = 2 \sum_{\alpha, \beta} e_{\alpha i} \frac{v_\beta}{v_d} \lambda_{\alpha\beta k}^e \quad Y_{ik}^d = - \sum_\alpha \frac{v_\alpha}{v_d} \lambda_{\alpha ik}^d \quad (33)$$

$$\lambda_{ijk} = \sum_{\alpha, \beta} e_{\alpha i} e_{\beta j} \lambda_{\alpha\beta k}^e \quad \lambda'_{ijk} = \sum_\alpha e_{\alpha i} \lambda_{\alpha jk}^d \quad (34)$$

Due to the residual term  $L_3 H_u$ , the tau neutrino acquires a mass through mixing with the neutralinos [84]:

$$m_{\nu_3} = m_0 \tan^2 \xi \quad m_0 \sim (100 \text{ GeV}) \cos^2 \beta \left( \frac{500 \text{ GeV}}{\tilde{m}} \right) \quad (35)$$

where  $\tilde{m}$  is a typical supersymmetry breaking scale, and the exact value of  $m_0$  depends on the gaugino masses,  $\mu$  and  $\tan \beta$ . To be compatible with the LEP limit on  $m_{\nu_\tau}$ , and with the even stronger cosmological bound on neutrino masses ( $m_\nu \leq \mathcal{O}(10 \text{ eV})$  for a stable doublet neutrino), one needs a strong alignment ( $\sin \xi \ll 1$ ) of the  $v_\alpha$  along the  $\mu_\alpha$ .

Let us specify formulae (31), (33), (34) and (35) in the presence of an abelian family symmetry. Assuming that the bilinear terms are generated through supersymmetry breaking [85] (which ensures that the  $\mu_\alpha$  are of the order of the weak scale, as required by electroweak symmetry breaking), one finds:

$$\mu_\alpha \sim \tilde{m} \epsilon^{\tilde{l}_\alpha} \quad v_\alpha \sim v_d \epsilon^{\tilde{l}_\alpha - \tilde{l}_0} \quad (36)$$

where  $\tilde{l}_\alpha \equiv |l_\alpha + h_u|$ , and the above estimates are valid for  $0 \leq \tilde{l}_0 < \tilde{l}_i$ ,  $i = 1, 2, 3$ . Thus the  $v_\alpha$  are approximately aligned along the  $\mu_\alpha$  by the family symmetry [78], which implies (assuming with no loss of generality  $\tilde{l}_3 \leq \tilde{l}_{1,2}$ ):

$$\sin^2 \xi \sim \epsilon^{2(\tilde{l}_3 - \tilde{l}_0)} \quad (37)$$

Furthermore, the redefinition (31) is completely fixed by requiring  $L_1 \simeq \hat{L}_1$  and  $L_2 \simeq \hat{L}_2$ , with

$$\frac{v_\alpha}{v_d} \sim \epsilon^{\tilde{l}_\alpha - \tilde{l}_0} \quad e_{\alpha i} \sim \epsilon^{|\tilde{l}_\alpha - \tilde{l}_i|} \quad (38)$$

Note that  $H_d \simeq \hat{L}_0$ , which allows us to define  $h_d \equiv l_0$ .

The low-energy  $R$ -parity violating couplings depend on the signs of the charges  $l_\alpha + h_u$ . In all phenomenologically viable cases, the order of magnitude relations (24) and (25) are modified to:

$$\lambda_{ijk} \sim \epsilon^{\tilde{l}_i - \tilde{l}_0} Y_{jk}^e \quad (39)$$

$$\lambda'_{ijk} \sim \epsilon^{\tilde{l}_i - \tilde{l}_0} Y_{jk}^d \quad (40)$$

By combining the eqs. (35), (37), (39) and (40), we can write down a relation between the mass of the tau neutrino,  $R$ -parity violating couplings  $\lambda'$  and down-quark Yukawa couplings

$$m_{\nu_3} \sim m_0 \left( \frac{\lambda'_{3jk}}{\lambda_{jk}^d} \right)^2 \quad (41)$$

which is a generic prediction of this class of models.

For the sake of simplicity, we shall only describe two cases of interest. The first one, in which all  $l_\alpha + h_u$  are positive, yields the standard Froggat and Nielsen structure:

$$Y_{ik}^e \sim \epsilon^{h_d+l_i+e_k} \quad \lambda_{ijk} \sim \epsilon^{l_i+l_j+e_k} \quad (42)$$

$$Y_{ik}^d \sim \epsilon^{h_d+q_i+d_k} \quad \lambda'_{ijk} \sim \epsilon^{l_i+q_j+d_k} \quad (43)$$

The second one, in which  $l_i + h_u \geq 0 > l_0 + h_u$ , leads to an enhancement of flavour diagonal couplings relative to off-diagonal couplings. Indeed, the dominant terms in (33) and (34) correspond to  $\alpha = 0$  or  $\beta = 0$ , which provides an alignment of the  $R$ -parity violating couplings along the Yukawa couplings:

$$\lambda_{ijk} \simeq \frac{1}{2} (e_{0j} Y_{ik}^e - e_{0i} Y_{jk}^e) \quad (44)$$

$$\lambda'_{ijk} \simeq -e_{0i} Y_{jk}^d \quad (45)$$

As a consequence,  $R$ -parity violating couplings are almost diagonal in the basis of fermion mass eigenstates. Furthermore, they undergo an enhancement relative to the naive power counting, since e.g.

$$\lambda'_{ijk} \sim \epsilon^{\tilde{l}_i - \tilde{l}_0} Y_{jk}^d \sim \epsilon^{-2\tilde{l}_0} \epsilon^{l_i+q_j+d_k} \quad (46)$$

This opens the phenomenologically interesting possibility that  $R$ -parity violation be sizeable while its contribution to FCNC processes is suppressed, as required by experimental data. Let us stress, however, that if the cosmological bound on neutrino mass is to be taken seriously, (37) indicates that  $R$ -parity violation should be very suppressed - unless some other mechanism provides the required alignment between the  $v_\alpha$  and the  $\mu_\alpha$ .

## 4 Single production of supersymmetric particles

### 4.1 Indirect effects

- **fermion pair production.** The alternative that direct production rates would turn to be too small at LEP energies, is a possibility that might be envisaged [86]. The reason could be either relatively heavy masses for supersymmetric particles or too weak couplings of the lighter particles with the  $\tilde{m}$  particles. In this case, the virtual effects of the  $\mathcal{R}_p$  interactions could lead to possible indirect signals. Sneutrino or squark t-channel exchange could contribute to processes  $e^+e^- \rightarrow f\bar{f}$  with  $f = e, \mu, \tau, b, c$  if  $\lambda$  or  $\lambda'$  couplings were present, respectively, assuming a single dominant coupling constant. For  $f = e$ , s-channel exchange is also possible. Since the angular distributions for the  $\tilde{m}$  and the  $\mathcal{R}_p$  contribution are different, it is proposed to divide the experimental angular width into bins, and to compare the observed number of events in each bin with the  $\tilde{m}$  prediction. A contour of the detectability in the  $\mathcal{R}_p$  coupling constant-sfermion mass plane gives some interesting bounds on some of the  $\lambda_{ijk}$  and  $\lambda'_{ijk}$  coupling constants. In [87], the contributions from t-channel exchange of squarks or sleptons to the process  $q\bar{q} \rightarrow t\bar{t}$  were studied. The comparison with the data from Tevatron on  $t\bar{t}$  production is used to constrain the B-violating  $\lambda''$  couplings and the L-violating  $\lambda$  couplings.

- **CP violation asymmetries.** The effects of  $R$ -parity interactions on flavor changing rates and CP asymmetries in the production of fermion-antifermion pairs at leptonic colliders are examined in [88]. In the reactions,  $e^- + e^+ \rightarrow f_J + \bar{f}_{J'}$ , [ $J \neq J'$ ], the produced fermions may be leptons, down-quarks or up-quarks, and the center of mass energies may range from the Z-boson pole up to 1000 GeV. Off the Z-boson pole, the flavor changing rates are controlled by tree level amplitudes and the CP asymmetries by interference terms between tree and loop level amplitudes. At the Z-boson pole, both observables involve loop amplitudes. The lepton number violating interactions, associated with the coupling constants,  $\lambda_{ijk}$ ,  $\lambda'_{ijk}$ , are only taken into account. The consideration of loop amplitudes is restricted to the Z-boson vertex corrections. The Z-boson decays branching ratios,  $B_{JJ'} = B(Z \rightarrow l_J^- + l_{J'}^+)$ , scale in order of magnitude as,  $B_{JJ'} \approx (\frac{\lambda}{0.1})^4 (\frac{100\text{GeV}}{\tilde{m}})^{2.5} 10^{-9}$ , and the off Z-boson pole rates as,  $\sigma_{JJ'} \approx (\frac{\lambda}{0.1})^4 (\frac{100\text{GeV}}{\tilde{m}})^{3.5} 10^2 \text{fbarns}$ . The corresponding results for quarks have an extra color factor,  $N_c = 3$ . The CP asymmetries at the Z-boson pole,  $A_{JJ'} = \frac{B_{JJ'} - B_{J'J}}{B_{JJ'} + B_{J'J}}$ , vary in the range,  $10^0, 10^{-1} \sin \psi$ , where  $\psi$  is the CP odd phase. The off Z-boson pole asymmetries,  $A_{JJ'} = \frac{\sigma_{JJ'} - \sigma_{J'J}}{\sigma_{JJ'} + \sigma_{J'J}}$ , lie at  $10^{-3} \sin \psi$  for leptons and d-quarks and reach  $\sin \psi$  order of magnitude for reactions (such as  $t\bar{c} + \bar{t}c$ ) involving one top-quark in the final state.

### 4.2 Single production

#### 4.2.1 Resonant production at LEP

- **Bhabha scattering.** The only single resonant production which is allowed at leptonic colliders is the sneutrino production, via  $\lambda_{ijk}$  couplings. This was first considered in [12], as a contribution to Bhabha scattering:  $e^+e^- \rightarrow \tilde{\nu} \rightarrow e^+e^-$ . The characteristic quantity describing the  $\tilde{\nu} - Z^0$  interferences is:  $\frac{e^+e^- \text{ event rate at } \tilde{\nu} \text{ peak}}{e^+e^- \text{ event rate at } Z^0 \text{ peak}} \approx 100 (\frac{100\text{GeV}}{m_{\tilde{\nu}}}) (\frac{250\text{MeV}}{\Delta E}) (\frac{\lambda}{0.2})^2$  where  $\Delta E$  is the beam spread. If  $\tilde{\nu} \rightarrow \nu \tilde{\chi}^0$  dominates over  $\tilde{\nu} \rightarrow e^+e^-$ , all is not lost since this would give new signals associated with the  $\mathcal{R}_p$  decay of  $\tilde{\chi}^0$ . Cross sections for reactions  $e^+e^- \rightarrow e^+e^-$  and  $e^+e^- \rightarrow \tilde{\chi}^0 \nu, \tilde{\chi}^\pm l^\mp$  via a resonant sneutrino have been computed in [13]. Bounds have been deduced on  $\mathcal{R}_p$  coupling constants by comparing with experimental results, from TRISTAN data, on Bhabha scattering and events with two or more charged leptons plus missing energy. Motivated by the interpretation of the very small x and high  $Q^2$  events reported at HERA [91], based on charm squark production with a squark mass of order  $m_{\tilde{c}} \simeq 200\text{GeV}$  [90], J. Kalinowski et al., [95] have considered the corrections to Bhabha scattering for LEP II energies. Using the indirect known bounds on the products  $\lambda\lambda'$ , they argue that if the HERA data are interpreted as charm squark production (i.e.  $\lambda'_{121} > 0.05$ ), then  $\lambda_{131}$  and  $\lambda_{123}$  are weakly constrained. At  $\sqrt{s} = 192\text{GeV}$ , the relative correction effect from the sneutrino exchange,  $\frac{\sigma(SM+\tilde{\nu})}{\sigma(SM)} - 1$ , lies between  $3.10^{-1}$  and  $4.10^{-3}$ , for  $200\text{GeV} < m_{\tilde{\nu}} < 500\text{GeV}$ , using  $\lambda_{131} = 0.1$ . For the sneutrino  $\tilde{\nu}_\tau$  resonance, cross sections values reach 300pb for  $\sqrt{s} = m_{\tilde{\nu}_\tau} = 200\text{GeV}$  if  $\lambda_{131} = 0.1$ . With the same coupling constant  $\lambda_{131}$ , sneutrino exchange in t-channel could also contribute to  $e^+e^- \rightarrow \tau^+\tau^-$ . The effect lies between  $6.5 \cdot 10^{-3}$  and  $1.5 \cdot 10^{-4}$  for the same choice of parameters. A dominant  $\lambda_{123}$  would affect  $\mu^+\mu^-$  and  $\tau^+\tau^-$  pair production would.

- **$b\bar{b}$  production.**[94] The sneutrino  $\tilde{\nu}_\tau$  exchange contribution to the process  $e^+e^- \rightarrow \tilde{\nu}_\tau \rightarrow b\bar{b}$  is especially promising because the Yukawa renormalisation of the scalar particle spectrum typically gives the third generation scalar field lighter than the first two. The authors have concentrated on  $b\bar{b}$  production since this one has a factor

$\lambda_{131}^2 \lambda_{333}'^2$ , giving sneutrino width,  $\Gamma_{\tilde{\nu}_\tau} \approx 6 GeV \lambda_{333}'^2 (\frac{m_{\tilde{\nu}_\tau}}{100 GeV})$ . By calculating the required luminosity to get a  $5\sigma$   $b\bar{b}$  excess from sneutrino resonance with  $\sqrt{s} \approx m_{\tilde{\nu}} \approx 190 GeV$ , they concluded that values of the product  $\lambda_{131} \lambda_{333}'$  more than two order magnitude below actual bounds ( $\lambda_{131} \lambda_{333}' < 0.075 (\frac{m_{\tilde{\nu}_\tau}}{100 GeV})^2$  from  $B \rightarrow e\tilde{\nu}$ ) could be probed by the LEP experiments. In case where the sneutrino peak is near the Z peak, sneutrino resonance could be still observable since it increases the branching ratio  $R_b = B(Z \rightarrow b\bar{b})$  and reduces the b quark forward-backward asymmetry  $A_{FB}(b)$ .

• **Experimental searches.** A recent study by the DELPHI Collaboration [97] has analysed sample of events at  $\sqrt{s} = 161$  and  $172 GeV$ . They account for sneutrino resonant production, followed by the  $R_p$  decays,  $\tilde{\nu} \rightarrow b\bar{b}$  and  $\tilde{\nu} \rightarrow \tilde{\chi}^0 \nu \rightarrow e^+ e^- \nu \nu$ . Using the same cuts for the data and the simulated background and signal, they find bounds on the coupling constant  $\lambda$  between 0.002 and 0.04, and on  $\lambda'$  between 0.003 and 0.014, for  $100 GeV < m_{\tilde{\nu}} < 200 GeV$ .

## 4.2.2 Resonant production at Tevatron and LHC

The first systematic study of final states for the high energy hadron colliders was given in [14]. H. Dreiner and G. G. Ross described all the different final state signatures, taking into account  $R_p$  coupling constants in decays and both  $R_p$  (single or resonant) and RPC (pair) supersymmetric production mechanisms. Furthermore, analytic expressions of rates were given for each superpartner decay. The encouraging conclusion was that in all cases,  $R_p$  violation leads to new visible signals for physics at LHC or Tevatron. This is due largely to an important rôle played by the RPC cascade decays into LSP. S. Dimopoulos et al., have presented in [89] cross sections for all resonant superparticle production at the Fermilab Tevatron:  $p\bar{p} \rightarrow \tilde{l}$  and  $p\bar{p} \rightarrow \tilde{\nu}$  via  $\lambda_{ijk}$  interactions or  $p\bar{p} \rightarrow \tilde{q}$  via  $\lambda'_{ijk}$  interactions. For  $\sqrt{s} < 2 TeV$ , the rates range between  $10^{-1} nb$  and  $10^{-4} nb$  in the interval  $20 GeV < \tilde{m} < 250 GeV$ , if  $\lambda = \lambda' = 1$ . If the produced sleptons decay to leptons via  $\lambda$  couplings, a large range of sleptons masses and  $\lambda$  coupling constants can be explored. The slepton decays to pairs of jets via  $\lambda'$  coupling constants are not favorable because the QCD background is important. Cross sections for the single production reactions:  $p\bar{p} \rightarrow \nu \tilde{\gamma}, l \tilde{\gamma}, q \tilde{g}$  range between  $10^{-5}$  and  $10^{-1} nb$  for the same choice of parameters as above. Some of the final states have small background, as for exemple in the case where the photinos decays via  $\lambda'$  into a lepton and two jets.

• **Single top quark production.** The process  $p\bar{p} \rightarrow q\bar{q}' \rightarrow t\bar{b}$  at the Tevatron induced by couplings  $\lambda'$  (via the exchange of a squark in the t-channel) and by couplings  $\lambda$  and  $\lambda'$  (via the exchange of a slepton in the s-channel) has been studied in [92]. It was found that the upgraded Tevatron can probe efficiently the  $\lambda'$  couplings, but less so the  $\lambda$  couplings. In [93], the single top quark production via the processes,  $q\bar{q}' \rightarrow slepton \rightarrow t\bar{b}$  and  $q\bar{q}' \rightarrow squark \rightarrow t\bar{b}$  at Tevatron and LHC, respectively, were investigated. R. J. Oakes et al., found that given the existing bounds on  $R_p$  coupling constants, single top quark production by  $R_p$  may be greatly enhanced over the RPC contribution, and that both colliders can set strong constraints on the relevant  $R_p$  coupling constants. They further found that the LHC is more powerful than the Tevatron in probing the squark couplings, but the two colliders have comparable sensitivity for the slepton couplings.

• **Sneutrino and slepton production.** The  $\tilde{\nu}$  and  $\tilde{l}$  resonant production for  $p\bar{p}$  collisions (via  $\lambda'$ ) in combination with their decays to leptons (via  $\lambda$ ), was studied in [96]. Coupling constants product  $\lambda_{131} \lambda_{311}'$  was chosen to produce  $\tilde{\tau}$  or  $\tilde{\nu}_\tau$ . The cross sections for:  $p\bar{p} \rightarrow \tilde{\nu}_\tau \rightarrow e^+ e^-$  and  $p\bar{p} \rightarrow \tilde{\tau} \rightarrow e^+ e^-$  range between 0.015 and 0.8pb for the set of parameters:  $\sqrt{s} = 1.8 TeV$ ,  $\lambda_{131} \lambda_{311}' = (0.05)^2$  and  $\Gamma_{\tilde{\nu}_\tau} = \Gamma_{\tilde{\tau}} = 1 GeV$ . A study of the di-electron invariant mass distribution for the process  $p\bar{p} \rightarrow e^+ e^-$  gives a constraint on the product  $\lambda_{131} \lambda_{311}'$ , assuming the sneutrino contribution to be smaller than the experimental error of the data points. For  $m_{\tilde{\nu}} = 200 GeV$  and at  $\sqrt{s} = 1.8 TeV$ , the constraint obtained from Tevatron data was:  $(\lambda_{131} \lambda_{311}')^{1/2} < 0.08 \Gamma_{\tilde{\nu}_\tau}^{1/4}$ . A bound can also be deduced from the contribution of the process  $e^+ e^- \rightarrow \tilde{\nu}_\tau \rightarrow p\bar{p}$  to the inclusive reaction  $e^+ e^- \rightarrow hadrons$ . The constraint is  $(\lambda_{131} \lambda_{311}')^{1/2} < 0.072(0.045)$  from LEP data, at  $\sqrt{s} = 184(192) GeV$  and for  $m_{\tilde{\nu}_\tau} = 200 GeV$ .

## 4.3 Systematic study of single production

The studies of single resonant production are restricted to the hypothetical situation where the center of mass energy is chosen to be exactly the mass of a supersymmetric particle, which is not easy to achieve. The prospect in the distant future of disposing of high precision measurements from high energy supercolliders (LHC, NLC) makes it interesting to study single production for reactions such as  $2 \rightarrow 2$  body in a more systematic way.

• **Lepton-photon collisions.** B.C. Allanach et al., have examined in [98] for LEP and NLC energies, the processes:  $e^\pm \gamma \rightarrow e^\pm \tilde{\nu}, \tilde{e}^\pm \nu$ , where the photon is a tagged photon radiated by one of the colliding leptons. These processes could test seven of the 9  $\lambda_{ijk}$  coupling constants. The cross section for  $e^\pm \gamma \rightarrow \nu \tilde{e}^\pm$  is smaller

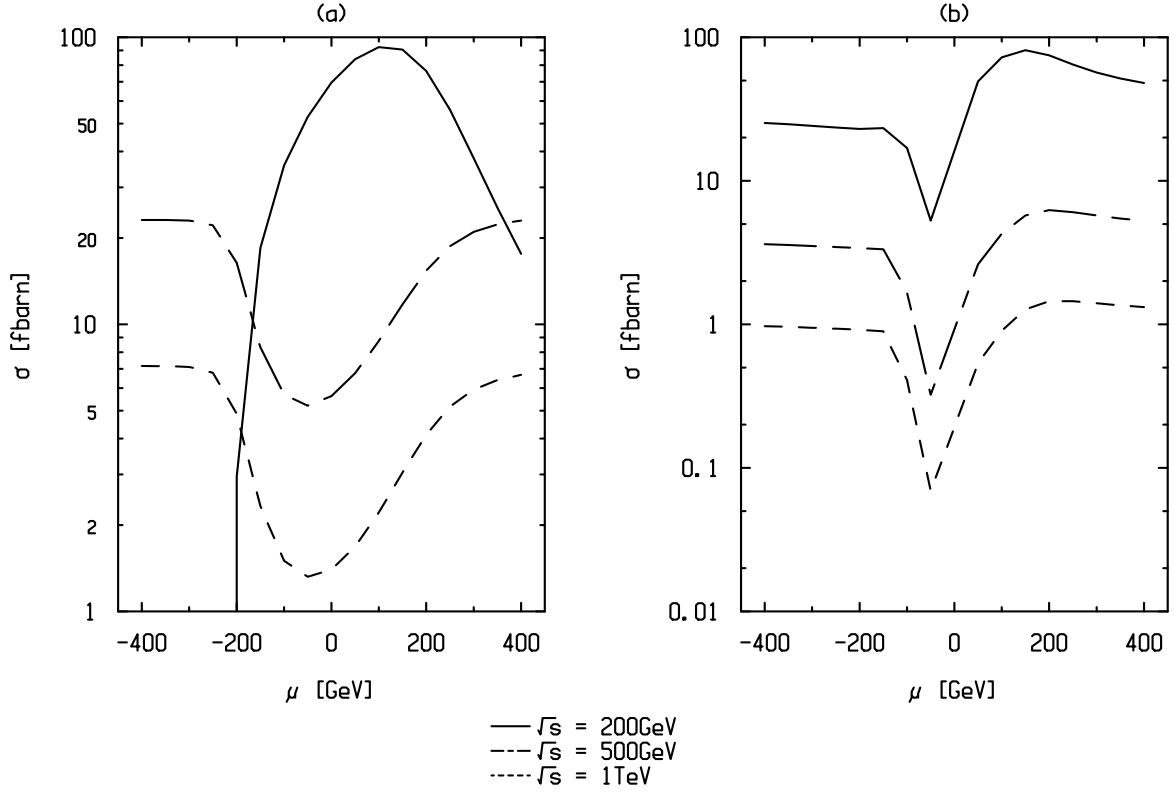

**Figure 1:** The cross sections for the processes  $e^+e^- \rightarrow \tilde{\chi}^\pm l^\mp$  (a) and  $e^+e^- \rightarrow \tilde{\chi}^0 \nu$  (b), as a function of  $\mu$ , using the set of parameters:  $M_2 = 200\text{GeV}$ ,  $m_0 = 150\text{GeV}$ ,  $\lambda_{m11} = 0.05$  and  $\tan\beta = 2$ . The different center of mass energies are indicated under the figures.

than that for  $e^\pm\gamma \rightarrow \tilde{\nu}e^\pm$  because the t-channel exchange amplitude involves a heavy slepton in the first reaction and a lepton in the second. For  $\lambda = 0.05$ , the sneutrino production cross section ranges between 30 and  $1000\text{fb}$  at  $\sqrt{s} = 192\text{GeV}$ , and between 6 and  $1000\text{fb}$  at  $\sqrt{s} = 500\text{GeV}$ . A Monte Carlo analysis was performed to investigate the sensitivity to the sneutrino signal, and  $5\sigma$  discovery contours in the  $m_{\tilde{\nu}}$  versus  $\lambda$  plane were presented. By comparing these contours with recent bounds on  $\lambda$ , B.C. Allanach et al., have concluded that sneutrinos with mass up to  $170\text{GeV}$  could be discovered in the near future of LEP II.

• **Systematics of single production at leptonic supercolliders** Indicative results for the processes:  $e^+e^- \rightarrow \tilde{\chi}^0 \nu$ ,  $\tilde{\chi}^\pm l^\mp$  are given in [99]. A systematic study of all the single production in  $e^+e^- \rightarrow$  two-body reactions at leptonic colliders,  $e^+e^- \rightarrow \tilde{\chi}^0 \nu$ ,  $\tilde{\chi}^\pm l^\mp$ ,  $\tilde{l}^\pm W^\mp$ ,  $\tilde{\nu} Z^0$ , and  $\tilde{\nu} \gamma$  is performed in [100]. A supergravity model is employed and a wide range of the parameter space is covered. As an illustration, we present in figure 1 some representative results. For the chosen values of  $M_2$  and  $\tan\beta$ , the pair production of charginos and neutralinos is kinematically forbidden at LEP II, for  $|\mu| > 100\text{GeV}$ . Branching ratios for the supersymmetric particles decays are calculated, assuming one dominant  $\lambda_{ijk}$  coupling constant.



# 5 On the discovery potential of HERA for $R$ -parity violating SUSY

## 5.1 Introduction

The search for squarks, the scalar supersymmetric (SUSY) partners of the quarks, is especially promising at the  $ep$  collider HERA if they possess a lepton number violating Yukawa coupling  $\lambda'$  to lepton-quark pairs. Such squarks, present in the  $R$ -parity violating ( $\tilde{R}_p$ ) SUSY extension of the Standard Model (SM), can be singly produced via the coupling  $\lambda'$  as  $s$ -channel resonances. Masses up to the kinematic limit of  $\sqrt{s} \simeq 300$  GeV are accessible by the fusion of the 27.5 GeV initial state positron with a quark from the 820 GeV incoming proton.

The interest in such new scalar bosons has been considerably renewed recently following the observation by the H1 [101] and ZEUS [102] experiments of an excess of events at very high masses and  $Q^2$ , above expectations from Standard Model (SM) neutral current (NC) and charged current (CC) deep-inelastic scattering (DIS). These early results were based on data samples collected in 1994 to 1996. Of particular interest was the apparent ‘‘clustering’’ of outstanding events at masses around 200 GeV observed in H1 which, although not specifically supported by ZEUS observations [103, 104], have motivated considerable work on leptoquarks [105] and  $\tilde{R}_p$  squarks [106] constraints and phenomenology.

In this report, the search at HERA for squarks through single production via a  $\tilde{R}_p$  coupling, considering both  $\tilde{R}_p$  decays and decays via gauge couplings involving mixed states of gauginos and higgsinos is investigated and the discovery potential of HERA beyond other existing colliders and indirect constraints from low energy processes is established.

## 5.2 Phenomenology

The general SUSY superpotential allows for gauge invariant terms with Yukawa couplings between the scalar squarks ( $\tilde{q}$ ) or sleptons ( $\tilde{l}$ ) and the known SM fermions. Such couplings violate the conservation of  $R$ -parity  $R_p = (-1)^{3B+L+2S}$  where  $S$  denotes the spin,  $B$  the baryon number and  $L$  the lepton number of the particles. To minimize the number of free parameters (couplings) in the theory, an exact conservation of  $R_p$  has traditionally been assumed in the context of the so-called Minimal Supersymmetric Standard Model (MSSM). But provided that (e.g.) baryon number is exactly conserved, sizeable lepton number violating Yukawa couplings are possible. The most general case, allowing for all such possible couplings, would lead to a complicated phenomenology. There are however theoretical motivations for a strong hierarchy of the  $\tilde{R}_p$  couplings [79], [81], [82], analogous to that observed for the known fermion masses, which simplify a lot the phenomenological implications of the existence of such couplings.

Non vanishing  $\tilde{R}_p$  couplings would have dramatic consequences in cosmology such as the instability of the lightest SUSY particle which otherwise could contribute to the dark matter in the universe, and a possibly important role in some baryogenesis models [67] and [107]. But the most important consequence is that the discovery of SUSY matter itself might be made through a sizeable  $\tilde{R}_p$  coupling. This has to do with the trivial fact that sparticles can be singly produced in the presence of  $\tilde{R}_p$  couplings and this might provide the crucial mass reach increase for collider facilities. The extension of the SUSY discovery potential in the presence of  $\tilde{R}_p$  couplings is particularly manifest at HERA. There, the search for  $R_p$  conserving MSSM through slepton-squark associated production via  $t$ -channel gaugino exchange only marginally probes the parameter space beyond existing LEP collider constraints [108].

Of particular interest for HERA are the  $\tilde{R}_p$  terms  $\lambda'_{ijk} L_i Q_j \bar{D}_k$  of the superpotential which allow for lepton number violating processes. By convention the  $ijk$  indices correspond to the generations of the superfields  $L_i$ ,  $Q_j$  and  $\bar{D}_k$  containing respectively the left-handed lepton doublet, quark doublet and the right handed quark singlet. Expanded in terms of matter fields, the interaction Lagrangian reads [110] :

$$\begin{aligned} \mathcal{L}_{L_i Q_j \bar{D}_k} = & \lambda'_{ijk} \left[ -\tilde{e}_L^i u_L^j \bar{d}_R^k - e_L^i \tilde{u}_L^j \bar{d}_R^k - (\tilde{e}_L^i)^c u_L^j \bar{d}_R^{k*} \right. \\ & \left. + \tilde{\nu}_L^i d_L^j \bar{d}_R^k + \nu_L^i \tilde{d}_L^j \bar{d}_R^k + (\tilde{\nu}_L^i)^c d_L^j \bar{d}_R^{k*} \right] + \text{h.c.} \end{aligned}$$

where the superscripts  $c$  denote the charge conjugate spinors and the  $*$  the complex conjugate of scalar fields. For the scalars the ‘R’ and ‘L’ indices distinguish independent fields describing superpartners of right- and left-handed fermions. Hence, with an  $e^+$  in the initial state, the couplings  $\lambda'_{ijk}$  allow for resonant production of squarks through positron-quark fusion. The list of possible single production processes is given in table 1.

**Figure 2:** Squark production cross-sections in  $ep$  collisions for a coupling  $\lambda' = 0.1$ .

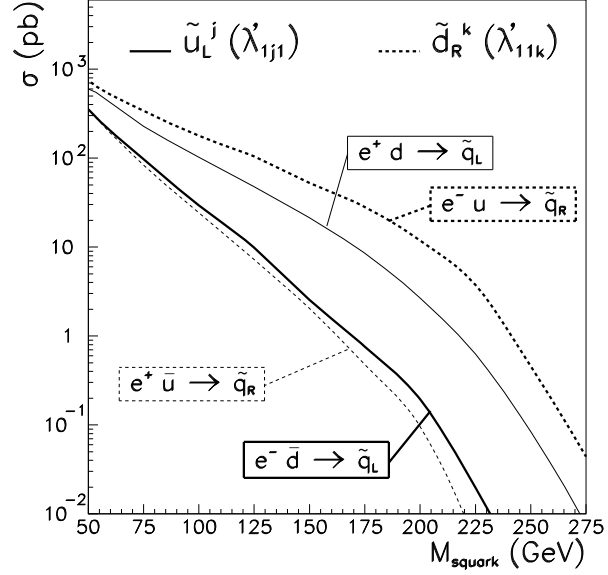

With an  $e^-$  beam, the corresponding charge conjugate processes are  $e^- u_j \rightarrow \tilde{d}_R^k$  ( $e^- \bar{d}_k \rightarrow \tilde{u}_L^j$ ) for  $u$ -like ( $d$ -like)

**Table 1:** Squark production processes at HERA ( $e^+$  beam) via a  $R$ -parity violating  $\lambda'_{1jk}$  coupling.

$\lambda'_{1jk}$	production process	
111	$e^+ + \bar{u} \rightarrow \tilde{d}_R$	$e^+ + d \rightarrow \tilde{u}_L$
112	$e^+ + \bar{u} \rightarrow \tilde{s}_R$	$e^+ + s \rightarrow \tilde{u}_L$
113	$e^+ + \bar{u} \rightarrow \tilde{b}_R$	$e^+ + b \rightarrow \tilde{u}_L$
121	$e^+ + \bar{c} \rightarrow \tilde{d}_R$	$e^+ + d \rightarrow \tilde{c}_L$
122	$e^+ + \bar{c} \rightarrow \tilde{s}_R$	$e^+ + s \rightarrow \tilde{c}_L$
123	$e^+ + \bar{c} \rightarrow \tilde{b}_R$	$e^+ + b \rightarrow \tilde{c}_L$
131	$e^+ + \bar{t} \rightarrow \tilde{d}_R$	$e^+ + d \rightarrow \tilde{t}_L$
132	$e^+ + \bar{t} \rightarrow \tilde{s}_R$	$e^+ + s \rightarrow \tilde{t}_L$
133	$e^+ + \bar{t} \rightarrow \tilde{b}_R$	$e^+ + b \rightarrow \tilde{t}_L$

quarks of the  $j$ th ( $k$ th) generation. Squark production via  $\lambda'_{1j1}$  is especially interesting in  $e^+p$  collisions as it involves a valence  $d$  quark, whilst  $\lambda'_{11k}$  are best probed with an  $e^-$  beam since squark production then involves a valence  $u$  quark. This is seen in Fig. 2 which shows the production cross-sections  $\sigma_{\tilde{q}}$  for “up”-like squarks  $\tilde{u}_L^j$  via  $\lambda'_{1j1}$ , and for “down”-like squarks  $\tilde{d}_R^k$  via  $\lambda'_{11k}$ , each plotted for coupling values of  $\lambda' = 0.1$ . In the narrow width approximation, these are simply expressed as

$$\sigma_{\tilde{q}} = \frac{\pi}{4s} \lambda'^2 q' \left( \frac{M^2}{s} \right) \quad (47)$$

where  $\sqrt{s} = \sqrt{4E_e^0 E_p^0} \simeq 300$  GeV is the energy available in the CM frame for incident beam energies of  $E_e^0 = 27.5$  GeV and  $E_p^0 = 820$  GeV, and  $q'(x)$  is the probability to find the relevant quark (e.g. the  $d$  for  $\tilde{u}_L$  and the  $\bar{u}$  for  $\tilde{d}_R$ ) with momentum fraction  $x = M^2/s \simeq M_{\tilde{q}}^2/s$  in the proton. Hence the production cross-section approximately scales in  $\lambda'^2$ .

The squark search at HERA reported here has been carried with the simplifying assumptions that:

- the lightest supersymmetric particle (LSP) is the lightest neutralino;

- gluinos are heavier than the squarks such that decays  $\tilde{q} \rightarrow q + \tilde{g}$  are kinematically forbidden.
- either one of the  $\lambda'_{1jk}$  dominates, or one product of couplings  $\lambda'_{1jk} \times \lambda'_{3jl}$  is non vanishing. This latter possibility, leading to lepton flavor violation processes will be addressed independently.

The squarks decay either via their Yukawa coupling into fermions, or via their gauge couplings into a quark and either a neutralino  $\chi_i^0$  ( $i = 1, 4$ ) or a chargino  $\chi_j^\pm$  ( $j = 1, 2$ ). The mass eigenstates  $\chi_i^0$  and  $\chi_j^\pm$  are mixed states of gauginos and higgsinos and are in general unstable. In contrast to the MSSM, this also holds in  $\tilde{R}_p$  SUSY for the lightest supersymmetric particle (LSP) which decays via  $\lambda'_{1jk}$  into a quark, an antiquark and a lepton [110].

Typical diagrams for the production of first generation squarks are shown in Fig. 3. By gauge symmetry only

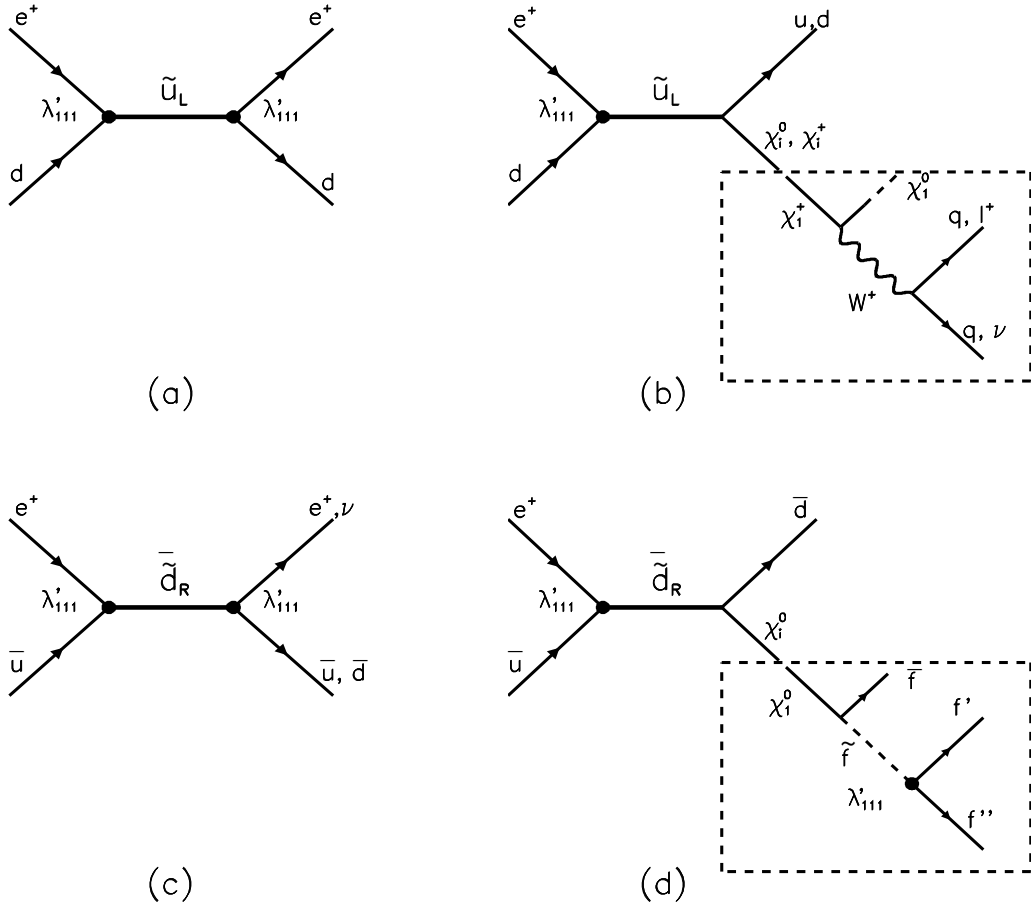

**Figure 3:** Lowest order  $s$ -channel diagrams for first generation squark production at HERA followed by (a),(c)  $\tilde{R}_p$  decays and (b),(d) gauge decays. In (b) and (d), the emerging neutralino or chargino might subsequently undergo  $\tilde{R}_p$  decays of which examples are shown in the dotted boxes for (b) the  $\chi_1^\pm$  and (d) the  $\chi_1^0$ .

the  $\tilde{d}_R$  and  $\tilde{u}_L$  are produced via the  $\lambda'$  couplings. These have in general widely different allowed or dominant decay modes.

In cases where both production and decay occur through a  $\lambda'_{1jk}$  coupling (e.g. Fig. 3a and c for  $\lambda'_{111} \neq 0$ ), the squarks behave as scalar leptoquarks [111, 112]. For  $\lambda'_{111} \neq 0$ , the  $\tilde{d}_R$  resemble the  $\tilde{S}^0$  leptoquark and decays in either  $e^+ + \bar{u}$  or  $\nu_e + \bar{d}$  while the  $\tilde{u}_L$  resemble the  $\tilde{S}_{1/2}$  and only decays into  $e^+d$ . Hence, the final state signatures consist of a lepton and a jet and are, event-by-event, indistinguishable from the SM neutral and charged current DIS. The strategy is then to look for resonances in DIS-like events at high mass, exploiting the characteristic angular distribution of the decay products expected for a scalar particle.

In cases where the squark decay occurs through gauge couplings (e.g. Fig. 3b and d), one has to consider for the  $\tilde{u}_L$  the processes  $\tilde{u}_L \rightarrow u\chi_i^0$  or  $d\chi_j^+$  while for the  $\tilde{d}_R^*$  only  $\tilde{d}_R \rightarrow \bar{d}\chi_i^0$  is allowed. This is because the  $SU(2)_L$  symmetry which implies in the SM that the right handed fermions do not couple to the  $W$  boson also forbids a coupling of  $\tilde{d}_R$  to the  $\tilde{W}$ . Hence, the  $\tilde{d}_R$  can only weakly couple (in proportion to the  $d$  quark mass) to the  $\chi_j^+$  through its higgsino component.

The possible decay modes of the chargino, when it is the lightest chargino  $\chi_1^+$ , are the gauge decays  $\chi_1^+ \rightarrow \chi_1^0 l^+ \nu$  and  $\chi_1^+ \rightarrow \chi_1^0 q \bar{q}'$ , and the  $\tilde{R}_p$  decays  $\chi_1^+ \rightarrow \nu u \bar{d}$  and  $\chi_1^+ \rightarrow e^+ d \bar{d}$ . The fate of the  $\chi_1^+$  depends on its gaugino-higgsino composition. The question of how this  $\chi_1^+$  nature depends on free fundamental parameters of the MSSM, as well as the corresponding  $\tilde{q}$  branching fractions for various possible decay channels will be discussed briefly in relation to our analysis in section 5.3 and was studied in more detail in [113, 114, 115]. In general, the  $\chi_1^+$  will undergo the decay  $\chi_1^+ \rightarrow e^+ q \bar{q}'$  or  $\chi_1^+ \rightarrow \nu q \bar{q}$ . The former will be dominant if the  $\chi_1^+$  is photino-like (i.e. dominated by photino components) in which case both the “right” and the “wrong” sign lepton (compared to incident beam) are equally probable leading to largely background free striking signatures for lepton number violation. The latter will dominate if the  $\chi_1^+$  is zino-like. A higgsino-like  $\chi_1^+$  could be long lived and escape detection since its coupling to fermion-sfermion pairs (e.g. Fig. 3d) is proportional to the fermion mass [116]. Hence processes involving a  $\tilde{H}$ -like  $\chi_1^0$  can be affected by an imbalance in transverse momenta.

Taking into account the dependence on the nature of the  $\chi_1^0$ , the possible decay chains of the  $\tilde{u}_L$  and  $\tilde{d}_R^*$  squarks has been classified in [113] in eight distinct event topologies among which we shall mostly concentrate here on the first four, namely:

- S1, high  $P_T$   $e^+ + 1$  jet, e.g.  $\tilde{q} \xrightarrow{\lambda'} e^+ q'$ ;
- S2, high  $P_{T,miss} + 1$  jet, e.g.  $\tilde{d}_R \xrightarrow{\lambda'} \nu e \bar{d}$ ;
- S3, high  $P_T$   $e^+ +$  multiple jets, e.g.  $\tilde{q} \rightarrow q\chi_1^0$  followed by  $\chi_1^0 \xrightarrow{\lambda'} e^+ \bar{q}' q''$ ;
- S4, High  $P_T$   $e^-$  (i.e. wrong sign) + multiple jets, e.g.  $\tilde{u}_L \rightarrow d\chi_1^+$  followed by  $\chi_1^+ \rightarrow W^+ \chi_1^0$  and  $\chi_1^0 \xrightarrow{\lambda'} e^- \bar{q}' q''$ ;

For a squark decaying into a quark and the lightest neutralino, the partial width can be written as

$$\Gamma_{\tilde{q} \rightarrow \chi_1^0 q} = \frac{1}{8\pi} (A^2 + B^2) M_{\tilde{q}} \left( 1 - \frac{M_{\chi_1^0}^2}{M_{\tilde{q}}^2} \right)^2 \implies \Gamma_{\tilde{q} \rightarrow \tilde{\gamma} q} = \Gamma_{\tilde{q} \rightarrow e q'} \frac{2e^2 e_q^2}{\lambda'^2} \left( 1 - \frac{M_{\tilde{\gamma}}^2}{M_{\tilde{q}}^2} \right)^2$$

where  $A$  and  $B$  in the left expression are chiral couplings depending on the mixing matrix of the neutralinos. Detailed expressions for such couplings can be found in [116]. Under the simplifying assumption that the neutralino is a pure photino  $\tilde{\gamma}$ , this gauge decay width reduces to the expression on the right. Here we introduced the partial width  $\Gamma_{\tilde{q} \rightarrow e q'} = \lambda'^2 M_{\tilde{q}} / 16\pi$  for squarks undergoing  $\tilde{R}_p$  decays. It is seen that, in general, gauge decays contribute strongly at low  $\chi_1^0$  masses and small Yukawa couplings.

The case  $\lambda'_{131} \neq 0$  (or  $\lambda'_{132} \neq 0$ ) is of special interest [117] since it allows for direct production of the stop via  $e^+ d \rightarrow \tilde{t}$  ( $e^+ s \rightarrow \tilde{t}$ ). The stop is particular in the sense that a “light” stop mass eigenstate ( $\tilde{t}_1$ ) could (depending upon the free parameters of the model) exist much lighter than the top quark itself and lighter than other squarks. This applies only for the stop since the off-diagonal terms which appear in the mass matrix associated to the superpartners of chiral fermions are proportional to the partner fermion mass.

## 5.3 Results from HERA

The search for squarks or  $R$ -parity violating SUSY was originally carried [118, 113] by the H1 Collaboration at HERA for the first time combining  $\tilde{R}_p$  decays and gauge decays of the squarks. It has been very recently extended [119] to include the 1995  $\rightarrow$  1997 datasets which represent an increase of integrated luminosity of more than an order of magnitude. In view of the excess observed in particular by H1 [101] for NC-like (i.e.  $\tilde{R}_p$ -decay like) event topologies for mass  $M \sim 200$  GeV, it became particularly important to analyse the full available datasets in gauge-decay topologies. No deviations from Standard Model expectation was found and these channels were used by H1 in combination with the NC-like channel to derive exclusion domains.

The rejection limit obtained by H1 at 95% confidence level on  $\lambda'_{1j1}$  as a function of the  $\tilde{u}_L^j$  mass is shown in Fig. 4a for a specific choice of the MSSM parameters,  $\mu = -200$  GeV,  $M_2 = 70$  GeV and  $\tan \beta = 1.5$ . These have been set such that the lightest neutralino  $\chi_1^0$  is mainly dominated by its photino component and

its mass is about 40 GeV. The  $\chi_1^+$  and  $\chi_2^0$  appear nearly degenerate around 90 GeV. By combining three contributing channels S1, S3 and S4, H1 improves the sensitivity for squarks considerably compared to an analysis which would rely solely on  $\tilde{R}_p$  two-body decay of the squarks. For example, at masses  $M \sim 100$  GeV, an improvement of a factor  $\simeq 5$  is obtained beyond an analysis relying on NC-like data (i.e. channel S1). The

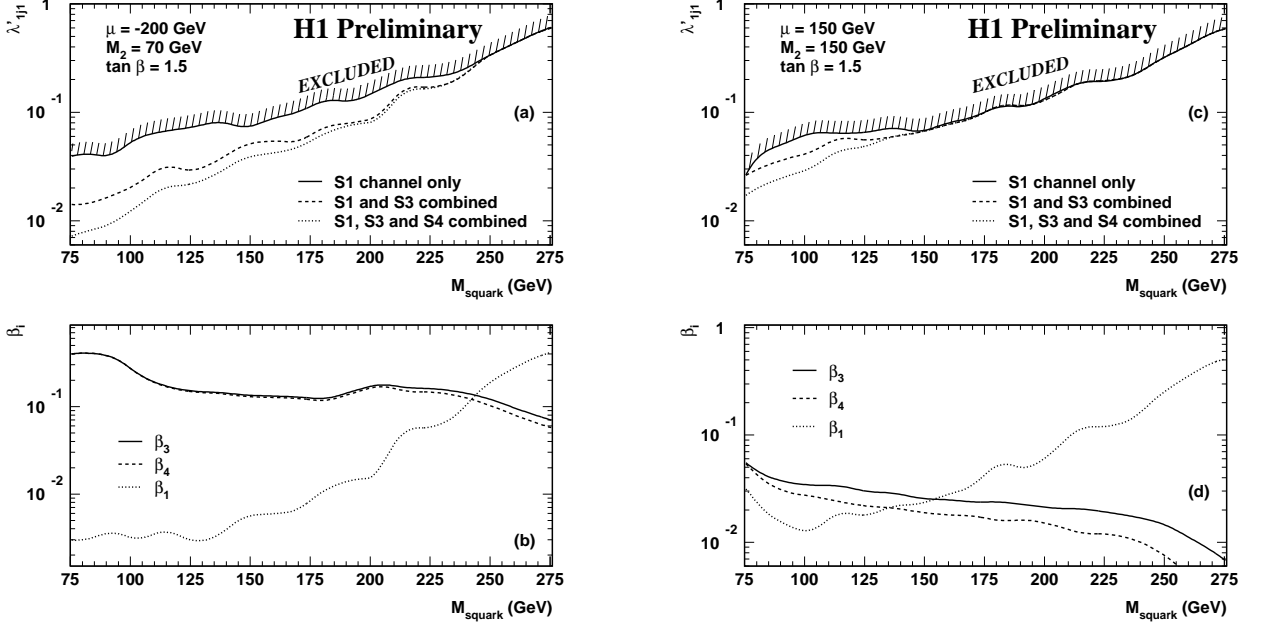

**Figure 4:** (a) Exclusion upper limits at 95% C.L. for the coupling  $\lambda'_{1j1}$  as a function of the squark mass for a specific set of MSSM parameters ( $M_{\chi_1^0} = 40$  GeV,  $\chi_1^0 \sim \tilde{g}\tilde{a}\tilde{m}$ , see text). Gauge and  $\tilde{R}_p$  decays of the squarks have been combined. Regions above the curves are excluded; (b) The relative contributions of channels S1, S3 and S4 versus the squark mass; (c) and (d) : as (a) and (b) but for a 40 GeV  $\chi_1^0$  dominated by its zino component.

branching ratios  $\beta_1$ ,  $\beta_3$  and  $\beta_4$  in channels S1, S3 and S4 respectively are shown on Fig. 4b versus the squark mass, at the sensitivity limit on the Yukawa coupling. For masses up to  $\simeq 230$  GeV, channels S3 and S4 dominate and contribute each at a similar level. As soon as squark decays into  $\chi_1^+$  and  $\chi_2^0$  become kinematically allowed,  $\beta_3$  and  $\beta_4$  are hampered by the fact that the both  $\chi_1^+$  and  $\chi_2^0$  decay preferentially into  $\nu q\bar{q}$  instead of  $e^\pm q q'$  (because they are dominated respectively by their wino and zino components [113]). In the very high mass domain, a large Yukawa coupling is necessary to allow squark production, hence the relative contribution of S1 is largely enhanced.

In order to study the dependence of our rejection limits on the MSSM parameters, another set of values for  $(\mu, M_2, \tan \beta)$  is chosen, which leads to 40 GeV  $\chi_1^0$  dominated by its zino component. The masses of  $\chi_1^+$  and  $\chi_2^0$  are respectively  $\simeq 100$  GeV and  $\simeq 72$  GeV, and  $\chi_2^0$  is mainly a  $\tilde{\gamma}$  state. As before, 95% C.L. limits on  $\lambda'_{1j1}$  versus the squark mass are displayed in Fig. 4c. The gain obtained by the combination of the three channels is less substantial than in previous case. Indeed, the  $\chi_1^0$  being here dominated by its  $\tilde{Z}$  component, it decays with a high branching ratio into  $\nu q\bar{q}$  instead of  $e^\pm q q'$ . The same holds for the lightest chargino. Hence, total branchings  $\beta_3$  and  $\beta_4$  are quite small though gauge decays of the squark are important. On the contrary to the “photino” case,  $\beta_3$  is here substantially higher than  $\beta_4$ . This is mainly due to the fact that the fraction of  $\tilde{R}_p$  decays into  $\nu q\bar{q}$  is smaller for the  $\chi_1^+$  than for the  $\chi_1^0$ . In fact, the dominant decay channel here would be the one labelled S5 in [113], leading to multijets +  $P_{T,miss}$  topology, which has not been addressed in this analysis. The separation of the signal from the SM background in this channel is however not easy, and, following the analysis presented in [113], we expect that the limit obtained when also combining S5 will not improve too much the result given here. Limits obtained when combining S1, S3 and S4 in the two cases detailed above

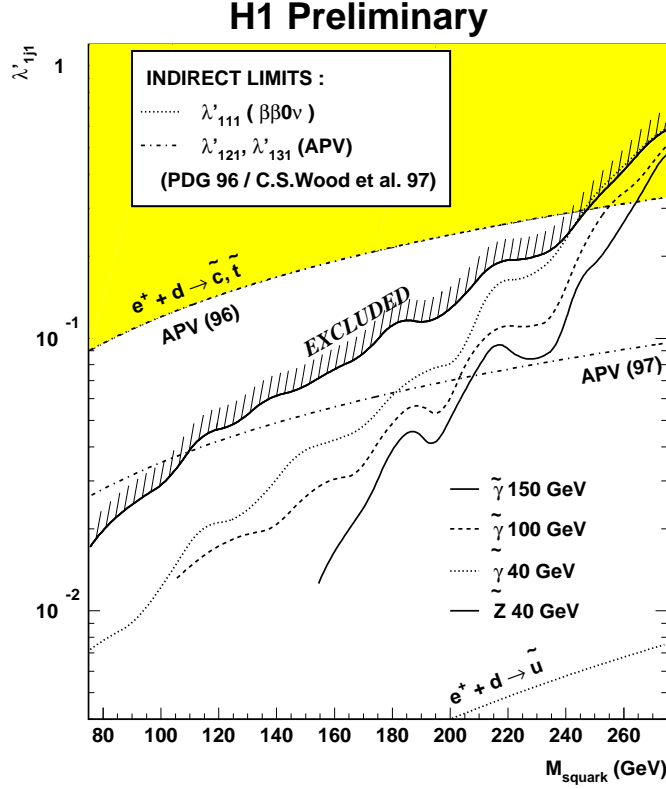

**Figure 5:** Exclusion upper limits at 95% C.L. for the coupling  $\lambda'_{1j1}$  as a function of squark mass, for various masses of a  $\tilde{\gamma}$ -like  $\chi_1^0$ ; the difference obtained between a 40 GeV  $\tilde{\gamma}$ -like and  $\tilde{Z}$ -like  $\chi_1^0$  is also shown; also represented are the most stringent indirect limits on  $\lambda'_{111}$  and  $\lambda'_{1j1}$ ,  $j = 2, 3$ .

are compared to each other in Fig. 5. Our sensitivity on  $\lambda'_{1j1}$  is better by a factor  $\simeq 2$  for squark masses below  $\simeq 200$  GeV for a  $\tilde{\gamma}$ -like  $\chi_1^0$  than for a  $\chi_1^0$  dominated by its zino component, due to the highest part of total branching actually “seen” by our analysis. One can infer from [113] that the two cases presented here are somewhat “extreme” and in that sense quite representative of the sensitivity we can achieve for any other choice of MSSM parameters leading to a 40 GeV  $\chi_1^0$ . The same figure shows the 95% C.L. limits obtained for a 100 GeV and a 150 GeV  $\tilde{\gamma}$ -like  $\chi_1^0$ . For electromagnetic coupling strengths  $\lambda'_{1j1}/4\pi \simeq \alpha_{em}$ , squark masses up to 262 GeV are excluded at 95% C.L. by this analysis, and up to 175 GeV for coupling strengths  $\gtrsim 0.01\alpha_{em}$ . For low masses, these limits represent an improvement of a factor  $\simeq 3$  compared to H1 previously published results.

We now turn to the case where two couplings  $\lambda'_{1j1}$  and  $\lambda'_{3jk}$  are non vanishing. On the contrary to what has been done above, we assume here that gauge decays of squarks are forbidden, so that the only squark decay modes are  $\tilde{u}_L^j \rightarrow e^+ + d$  and  $\tilde{u}_L^j \rightarrow \tau^+ + d^k$ .  $\tau$  + jet final states have been searched for in the hadronic decay mode of the  $\tau$  and no signal has been observed. Assuming a given value for the production coupling  $\lambda'_{1j1}$  exclusion limits at 95% C.L. on  $\lambda'_{3jk}$  have been derived combining both  $e$  + jet and  $\tau$  + jet channels. Results are shown in Fig. 6 versus the mass of  $\tilde{u}_L^j$ , for  $\lambda'_{1j1}$  equal to 0.3 (i.e. an electromagnetic coupling strength), 0.1 and 0.03. Greyed domains are excluded. For  $\lambda'_{1j1} = \lambda'_{3jk} = 0.03$ ,  $\tilde{u}_L^j$  squarks lighter than 165 GeV are excluded at 95% C.L. A similar analysis has been carried out by ZEUS Collaboration, with an integrated luminosity of  $\simeq 3 \text{ pb}^{-1}$  using  $e^+p$  1994 data [120]. Instead of fixing  $\lambda'_{1j1}$ , results were presented assuming  $\lambda'_{1j1} = \lambda'_{3jk}$ . When these two couplings are both equal to 0.03, the analysis presented here extends the excluded squark mass range by  $\simeq 65$  GeV.

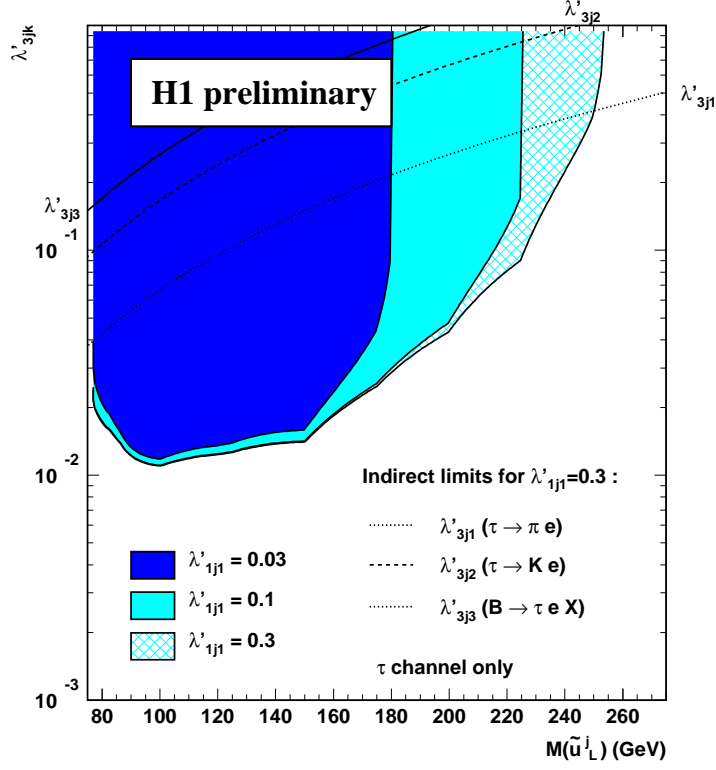

**Figure 6:** Exclusion upper limits at 95% C.L. for the coupling  $\lambda'_{3jk}$  as a function of squark mass, for several fixed values of  $\lambda'_{1j1}$  (greyed domains). The regions above the full, dashed and dot-dashed curves correspond to the best relevant indirect limits.

## 5.4 Constraints and Discovery Potential

Our results in the plane  $\lambda'_{1j1}$  versus  $M_{\tilde{q}}$ , under the hypothesis that one  $\lambda'_{1j1}$  dominates, are also compared in Fig. 5 to the best indirect limits. The most stringent comes from the non-observation of neutrinoless double beta decay, but only concerns  $\lambda'_{111}$  coupling. The most severe indirect limits on couplings  $\lambda'_{121}$  and  $\lambda'_{131}$ , which could allow for the production of squarks  $\tilde{c}$  and  $\tilde{t}$  respectively, come from Atomic Parity Violation. Two constraints are given on the figure which depend on the experimental input. H1 direct limits are thus better or comparable to the most stringent constraints on  $\lambda'_{121}$ ,  $\lambda'_{131}$ . For high masses of  $\chi_1^0$  our limit even improves these indirect constraints by a factor up to  $\simeq 4$ .

In the case where two couplings  $\lambda'_{1j1}$  and  $\lambda'_{3jk}$  are non vanishing, the only relevant indirect limits [121] come from the processes  $\tau \rightarrow \pi e$ ,  $\tau \rightarrow K e$  and  $B \rightarrow \tau e X$ , which constrain the products  $\lambda'_{1j1} \times \lambda'_{3jk}$ . These indirect limits are given in Fig. 6 for  $\lambda'_{1j1} = 0.3$ . H1 direct limits improve these constraints by typically one order of magnitude. Note that better indirect limits on couplings  $\lambda'_{3jk}$  exist, coming e.g. from  $\tau \rightarrow \pi \nu$ ,  $Z \rightarrow \tau \tau$  or  $K^+ \rightarrow \pi^+ \nu \bar{\nu}$ . However these only concern the  $\tilde{d}_R^k$  and can thus be evaded assuming e.g.  $\tilde{u}_L^j$  to be much lighter than other squarks.

Contrary to leptoquarks [112], it was seen above that the squarks accessible at HERA can naturally have a small branching ratio  $\mathcal{B}$  in  $\tilde{R}_p$  decay modes and thus can partly avoid the severe constraints set at the Tevatron for scalar leptoquarks [122]. The difficulty in explaining an excess in  $\tilde{R}_p$ -like decay channels such as that observed in the 1994-96 data set of H1 precisely resides in the necessity to maintain a sizeable product  $\lambda'_{1jk} \sqrt{\mathcal{B}}$  while respecting the Tevatron scalar leptoquark constraints which implies that  $\mathcal{B} < 0.5$  for  $M \simeq 200$  GeV and at the same time the upper limits on  $\lambda'_{1jk}$  coming from indirect processes. For example, considering the full amplitude of the NC-like excess observed in H1, the only viable scenarios are [106]:

Production process	estimate of $\lambda'\sqrt{\mathcal{B}}$	constraints on $\mathcal{B}$
$e_R^+ d_R \rightarrow \tilde{c}_L$	$\lambda'_{121}\sqrt{\mathcal{B}} \sim 0.025 - 0.033$	$0.1 \lesssim \mathcal{B} < 0.5$
$e_R^+ d_R \rightarrow \tilde{t}_L$	$\lambda'_{131}\sqrt{\mathcal{B}} \sim 0.025 - 0.033$	$0.1 \lesssim \mathcal{B} < 0.5$
$e_R^+ s_R \rightarrow \tilde{t}_L$	$\lambda'_{132}\sqrt{\mathcal{B}} \sim 0.15 - 0.25$	$0.07 \lesssim \mathcal{B} < 0.5$

Such branching ratios can only be met in small regions of the SUSY parameter space, regions which are moreover challenged by the search recently carried at LEP for  $\tilde{H}_p$  decays of charginos which sets a lower limit on  $M_{\chi^\pm}$  of  $\sim 90$  GeV.



## 6 Do we need conserved $R$ -parity at LEP?

In  $e^+e^-$  colliders such as LEP in its first phase i.e. running at the  $Z$  peak, the search for  $R_p$  effects mainly concerned leptonic topologies [123]. LEP in its second phase, i.e. LEP 2, is going to higher center of mass energies than the  $Z$  peak and, along with a deeper and wider interest to supersymmetry with  $R_p$  couplings, extends the search for  $R_p$  effects [124]. Assuming that one coupling dominates at one time, the effects of the  $R_p$  terms on the phenomenology can be classified in three parts:

- **effects in the decay** of the supersymmetric particles produced in pair (in the usual way) in  $e^+e^-$  interactions in which the  $\lambda_{ijk}$ ,  $\lambda'_{ijk}$  or  $\lambda''_{ijk}$  couplings can be involved;
- **single production** of a neutralino (with a neutrino), a chargino (with a charged lepton) or a resonant sneutrino, all involving  $\lambda_{ijk}$  couplings and also single production of a squark in  $\gamma e$  interactions that can occur in  $e^+e^-$  collisions via the interaction of a quark from a resolved  $\gamma$  radiated by one of the incoming particle ( $e^+$  or  $e^-$ ) with the other incoming particle, involving  $\lambda'_{ijk}$  couplings;
- **t-channel exchange** of a slepton via  $\lambda_{ijk}$  couplings, in the lepton-pair production  $e^+e^- \rightarrow l^+l^-$  or t-channel exchange of a squark via  $\lambda'_{ijk}$  couplings, in the quark-pair production  $e^+e^- \rightarrow q\bar{q}$  both giving deviation from the expectation of the Standard Model.

These effects have been experimentally searched for at the LEP collider. In the following, a short description and a very brief review is given on these experimental searches performed by the LEP collaborations, mainly based from already published papers and contributions submitted to conferences [125].

### 6.1 Effects of the $R$ -parity violating couplings in the decay

Neutralinos  $\tilde{\chi}_{1,2,3,4}^0$  and charginos  $\tilde{\chi}_{1,2}^\pm$  are gauginos that can be produced in pair in  $e^+e^-$  collisions via the ordinary couplings from supersymmetry with conserved  $R$ -parity [126]. In the  $s$ -channel, the gauginos are produced via the exchange of a  $\gamma$  or a  $Z$  (figure 7); in the  $t$ -channel, they can be produced via a selectron for the neutralinos, or a sneutrino for the charginos, if the slepton masses are low enough. When the selectron mass is sufficiently small ( $\lesssim 100 \text{ GeV}/c^2$ ), the neutralino production is enhanced. On the contrary, if the  $\tilde{\nu}_e$  mass is in the same range, the chargino cross section can decrease due to destructive interference between the  $s$ - and  $t$ -channel amplitudes. If the dominant component of neutralinos and charginos is the higgsino ( $|\mu| \ll M_2$ ), the production cross sections are large and insensitive to slepton masses.

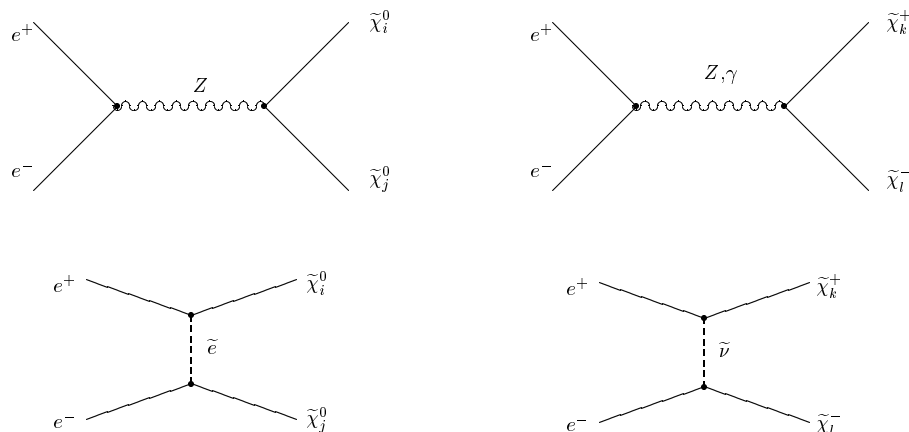

**Figure 7:** Gaugino pair production diagrams ( $i, j = 1, \dots, 4$ ;  $k, l = 1, 2$ )

Sfermions  $\tilde{f}$  i.e. sleptons and squarks, can also be produced in pair in  $e^+e^-$  collisions via the ordinary couplings from supersymmetry with conserved  $R$ -parity provided that their masses are kinematically accessible which is hoped to be the case for the sfermions of the third family, especially stop  $\tilde{t}$  and sbottom  $\tilde{b}$ , because of the splitting in mass of the mass-eigenstates.

In the presence of  $R_p$  terms in the superpotential, the lightest neutralino  $\tilde{\chi}_1^0$ , usually considered as the LSP (see [126] et [127]) can decay into a fermion and its virtual supersymmetric partner which then decays via the  $R_p$  couplings into two fermions. This decay chain gives rise to 3 fermions in the final state. For pair produced

supersymmetric particles like  $\tilde{\chi}_2^0$ ,  $\tilde{\chi}_{1,2}^\pm$  or  $\tilde{f}$  all heavier than the LSP  $\tilde{\chi}_1^0$ , the  $R_p$  decays can be classified into 2 categories:

- **indirect  $R_p$  (or cascade) decays.** The supersymmetric particle first decays through a  $R$ -parity conserving vertex to an on-shell supersymmetric particle till the LSP  $\tilde{\chi}_1^0$  which then decays, as described above, via one  $R_p$  coupling.
- **direct  $R_p$  decays.** The supersymmetric particle decays directly to standard particles through one  $R_p$  coupling.

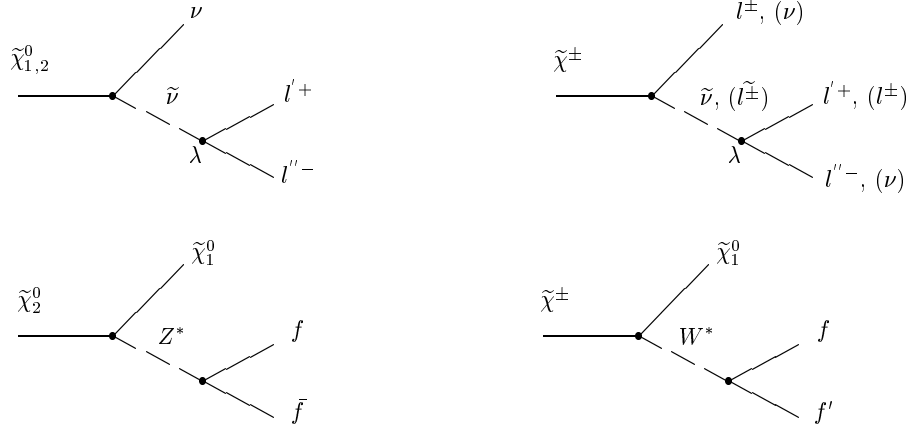

**Figure 8:** Gaugino direct (upper part) and indirect (lower part) decay diagrams

Some examples of direct and indirect decays of gauginos, when  $\lambda_{ijk}$  couplings are involved, are shown in figure 8, and the corresponding possible signatures are given in table 2.

Decay of supersymmetric particles via  $\lambda_{ijk}$  couplings give rise in general to **leptonic topologies** although one can see in table 2 that jets may be present in the final states in case of indirect gaugino decays.

final states	direct decay of	indirect decay of
$2l + \cancel{E}$	$\tilde{\chi}_1^+ \tilde{\chi}_1^-$	$\tilde{\chi}_2^0 \tilde{\chi}_1^0$
$4l + \cancel{E}$	$\tilde{\chi}_1^0 \tilde{\chi}_1^0, \tilde{\chi}_1^+ \tilde{\chi}_1^-$	$\tilde{\chi}_2^0 \tilde{\chi}_1^0$
$6l$	$\tilde{\chi}_1^+ \tilde{\chi}_1^-$	
$6l + \cancel{E}$		$\tilde{\chi}_1^+ \tilde{\chi}_1^-, \tilde{\chi}_2^0 \tilde{\chi}_1^0$
$4l + 2 \text{ jets} + \cancel{E}$		$\tilde{\chi}_2^0 \tilde{\chi}_1^0$
$4l + 4 \text{ jets} + \cancel{E}$		$\tilde{\chi}_1^+ \tilde{\chi}_1^-$
$5l + 2 \text{ jets} + \cancel{E}$		$\tilde{\chi}_1^+ \tilde{\chi}_1^-$

**Table 2:** Final states in gaugino pair production when a  $\lambda_{ijk}$  coupling is dominant

When  $\lambda'_{ijk}$  couplings are involved, decays of supersymmetric particles give rise in general to **semi-leptonic** topologies. A typical example of a direct supersymmetric particle decay into standard particles is the semi-leptonic decay of the stop  $\tilde{t}_1 \rightarrow lq$  giving rise to a 2 leptons + 2 jets signature. Another typical example is the direct decay of the  $\tilde{\chi}_1^0$  into 3 fermions which are one lepton (charged or neutral) and 2 quarks. The signature of a pair produced  $\tilde{\chi}_1^0$  followed by a decay via one violating  $R_p$  coupling  $\lambda'_{ijk}$  is then 2 leptons + 4 jets, 4 jets and missing energy when the leptons in the final state are neutrinos or 1 lepton + 4 jets and missing energy.

Still in the  $\lambda'_{ijk}$  dominance case, a typical example of indirect decay is the decay  $\tilde{\chi}_1^\pm \rightarrow \tilde{\chi}_1^0 W^{*\pm}$  with conserved  $R$ -parity followed by the  $R_p$  decay of the  $\tilde{\chi}_1^0$  as above giving rise to 2 leptons + 8 quarks, 4 leptons

+ 6 quarks or even 6 leptons + 4 quarks partonic final state in which the leptons may be charged or neutral (thus giving rise to missing energy) and in which the high multiplicity of quarks leads to a multijet pattern.

When  $\lambda''_{ijk}$  couplings are involved, decays of supersymmetric particles give rise in general to **multijet hadronic topologies** although, here again, leptons may be present in the final state in case of indirect decays of gauginos.

One can have 4 quarks in the partonic final state when a squark directly decay into 2 quarks (e.g.  $\tilde{t}_1 \rightarrow sb$ ) or 6 quarks for the direct decay  $\tilde{\chi}_1^0 \rightarrow qq'q''$ . One may have 8 or even 10 quarks in the partonic final state in case of indirect decay of squarks or charginos. For example one may have 10 quarks in chargino indirect decay:  $\tilde{\chi}_1^\pm \rightarrow \tilde{\chi}_1^0 W^{*\pm}$  followed by  $\tilde{\chi}_1^0 \rightarrow qq'q''$  and  $W^{*\pm} \rightarrow q_1 q_2$  as shown in figure 9 where  $f1, f2, f3, f4$  and  $f5$  stand for  $q1, q2, q, q'$  and  $q''$  respectively.

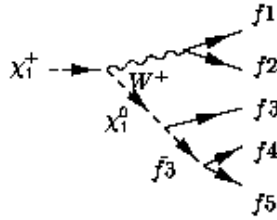

**Figure 9:** Example of cascade decay for chargino to LSP neutralino with  $\lambda''_{ijk}$  couplings

These partonic final state quarks hadronize into jets, giving a multijet pattern whose shape depends then on the boost of the initial supersymmetric particle. The schematic jet patterns for the 6-quarks partonic final states produced by the  $R_p$  decay of the neutralino pair at  $\sqrt{s} = 183$  GeV, for three masses of neutralino are given in figure 10 from which one can see that 6-quarks partonic final states can lead to 2-jets, 4-jets and 6-jets topologies, depending here only on the boost of each primary sparticle <sup>5</sup>.

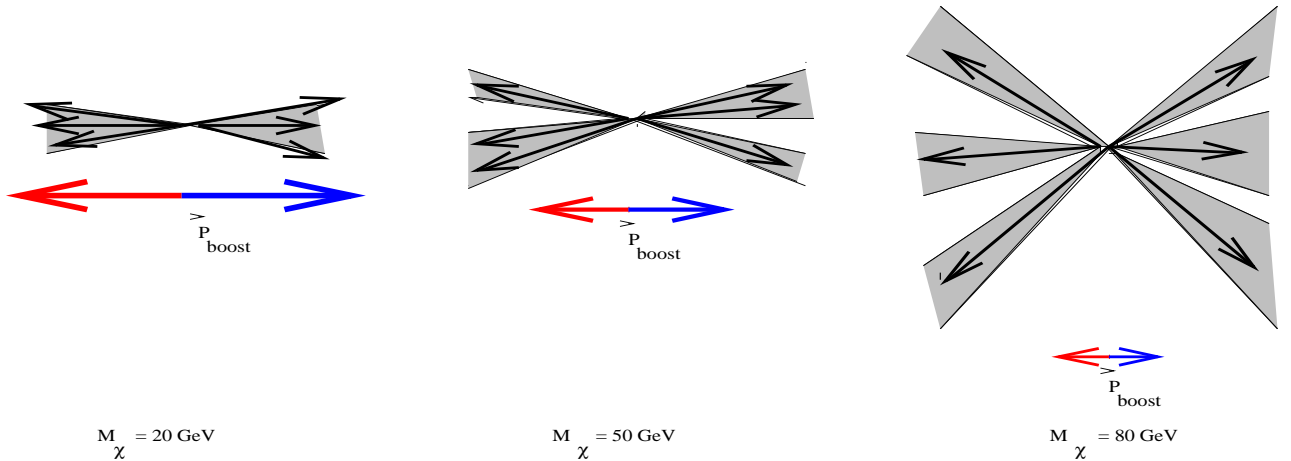

**Figure 10:** Schematic jet patterns for the 6-quarks partonic final states of neutralino pair decay with  $\lambda''_{ijk}$  couplings.

Now, still in the  $\lambda''_{ijk}$  couplings case for indirect chargino decay, if  $W^{*\pm} \rightarrow l\nu$ , one can see that leptons can be present in the topology/partonic final state which could then be 6 quarks + 2 charged leptons and missing

<sup>5</sup>Actually, the jet topology is also widely dependent on the resolution parameter of the employed jet-reconstructing algorithm

energy or 8 quarks + 1 charged lepton + missing energy. Leptons can also be present in case of a cascade decay of the type:  $\tilde{\chi}_2^0 \rightarrow \tilde{\chi}_1^0 Z$  followed by  $Z \rightarrow l^+ l^-$ .

The requirement that the sparticle decays within the detector (typically within 1 m) translates, for the energies and masses of interest at LEP, for a sfermion e.g. the  $\tilde{\nu}$  to weak lower bounds  $\lambda, \lambda' \gg 10^{-8}$  and for a gaugino e.g. the  $\tilde{\chi}_1^0$ , to weak lower bound  $\lambda \geq 3 \times 10^{-6}$ . For values of  $\lambda$  between  $10^{-5}$  and  $10^{-6}$  for the neutralinos/charginos and  $10^{-7}$ - $10^{-8}$  for the sfermions, the  $\mathcal{R}_p$  decays appear as displaced vertices in the detector. For weaker values of  $\lambda$  the  $\mathcal{R}_p$  signatures become indistinguishable from the  $R_p$  ones. Very low mass neutralinos decay outside the detector even for relatively high  $\lambda$  values. A further complication arises when  $\lambda'$  or  $\lambda'$  are involved and when the decay lifetimes to quarks become larger than the hadronization ones. Then the system hadronizes into a squark hadron before decaying and all the ambiguities in the modelization of the  $R_p$   $\tilde{t}$  decay become relevant for the  $\mathcal{R}_p$  decays. Experimental searches of pair produced gauginos and pair produced sfermions have been recently performed in the four LEP experiments in the context of  $\mathcal{R}_p$  couplings. These searches generally assume that there are no displaced vertices.

Using the 1996 and 1997 data of LEP, no evidence for  $\mathcal{R}_p$  signals have been found and limits on the masses of sfermions have been derived as well as limits on MSSM parameters relevant for the gauginos sector. Examples of these limits are given in figures 11 and figures 12 in cases of both direct and indirect decay of neutralinos and charginos.

Another example of these limits is given in figure 13 in case of the stop search (indicated by DELPHI pair) with a direct decay together with other searches described in the following.

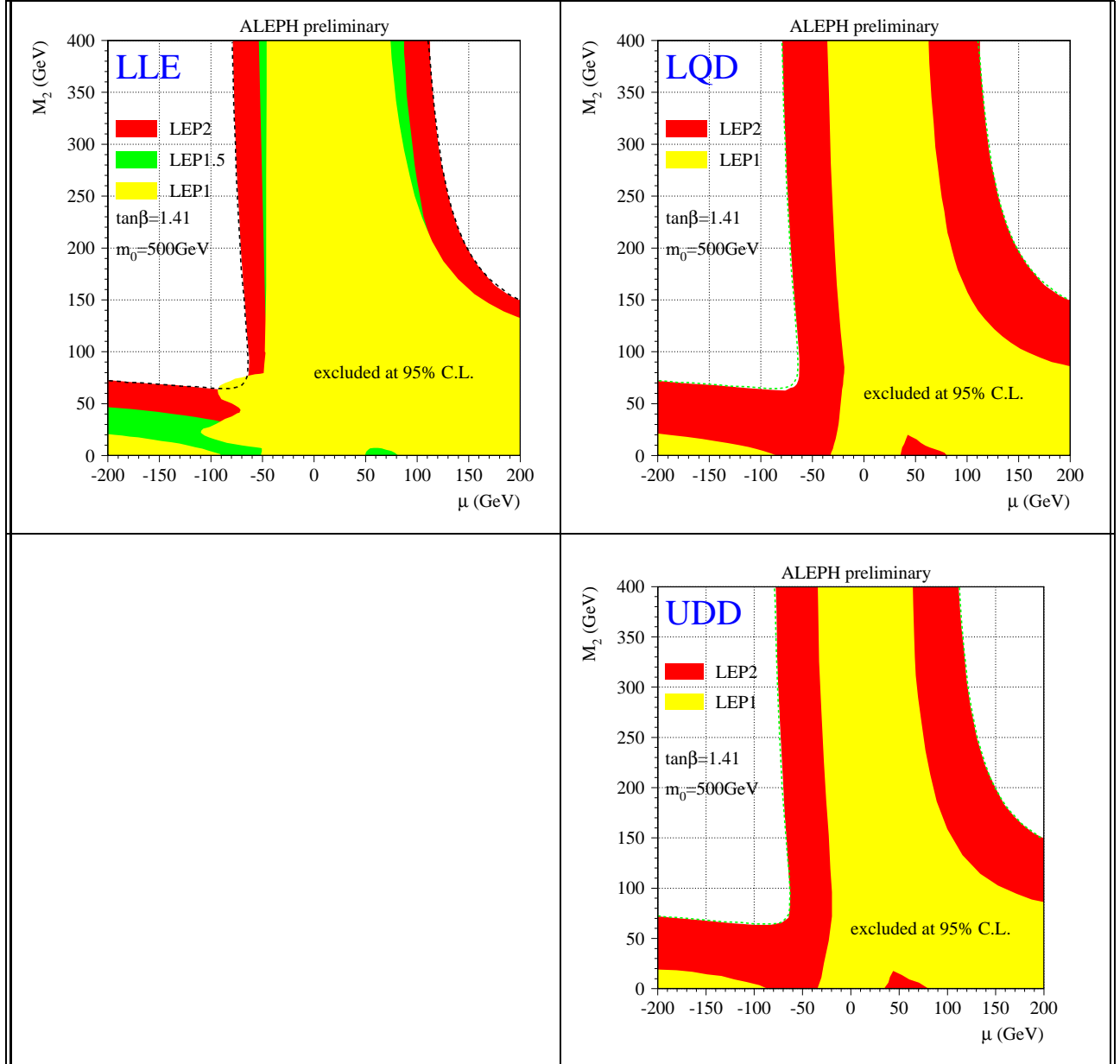

**Figure 11:** Charginos and Neutralinos 95 % C.L. exclusion in the  $\mu$ ,  $M_2$  plane for  $\tan\beta = \sqrt{2}$ . Valid for any choice of generation indices  $i, j, k$  of the couplings  $\lambda_{ijk}$ ,  $\lambda'_{ijk}$  and  $\lambda''_{ijk}$  and valid for  $m_0 = 500 \text{ GeV}/c^2$  i.e. large sfermion masses.

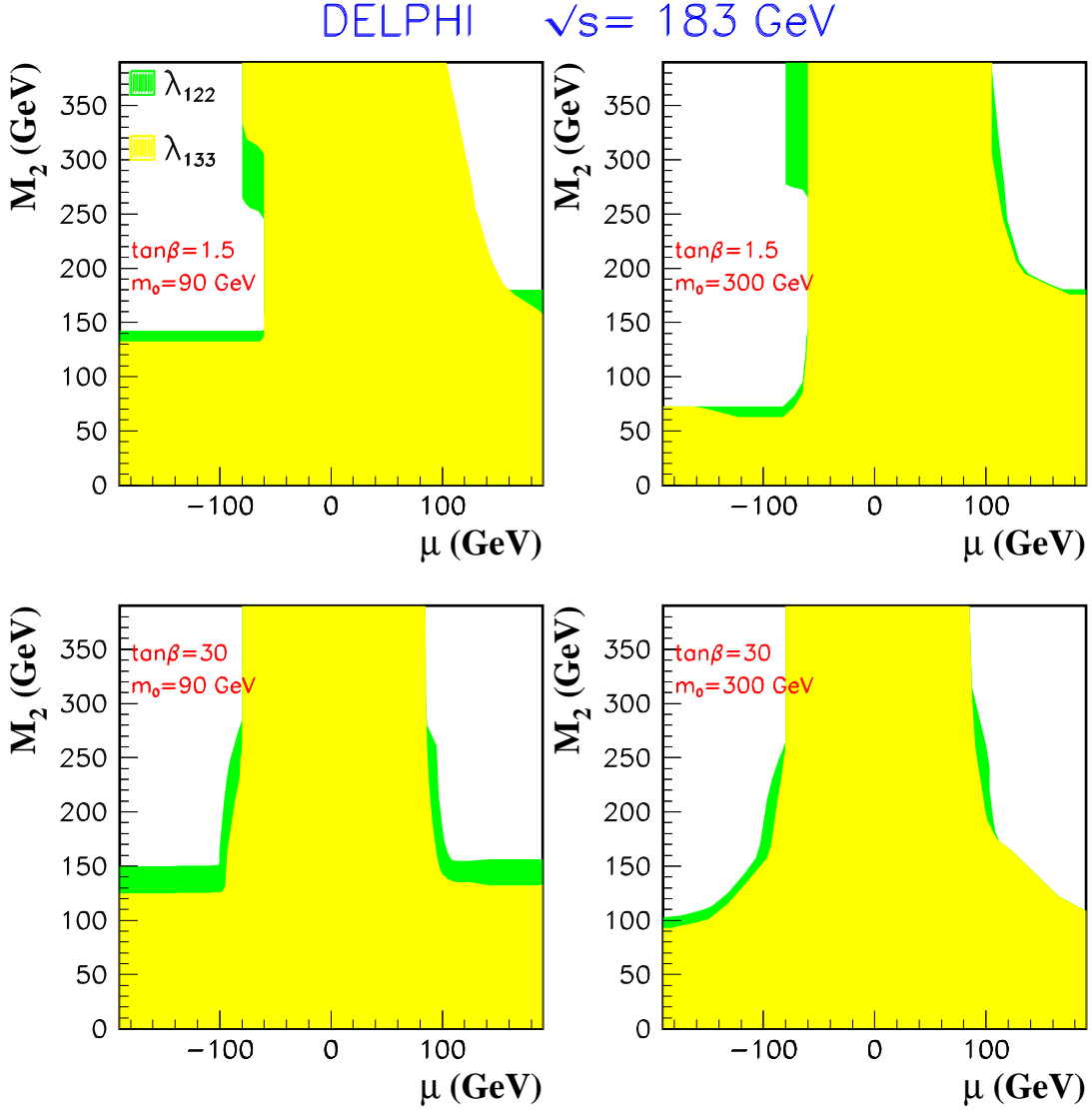

**Figure 12:** Regions in  $\mu$ ,  $M_2$  parameter space excluded at 95 % C.L. for two values of  $\tan\beta$  and two values of  $m_0$ . The exclusion area obtained from the  $\lambda_{133}$  search is shown in light grey and the corresponding area for the  $\lambda_{122}$  search is shown in dark grey. The second exclusion area includes the first. The data collected in DELPHI at  $E_{CM} = 183 \text{ GeV}$  are used.

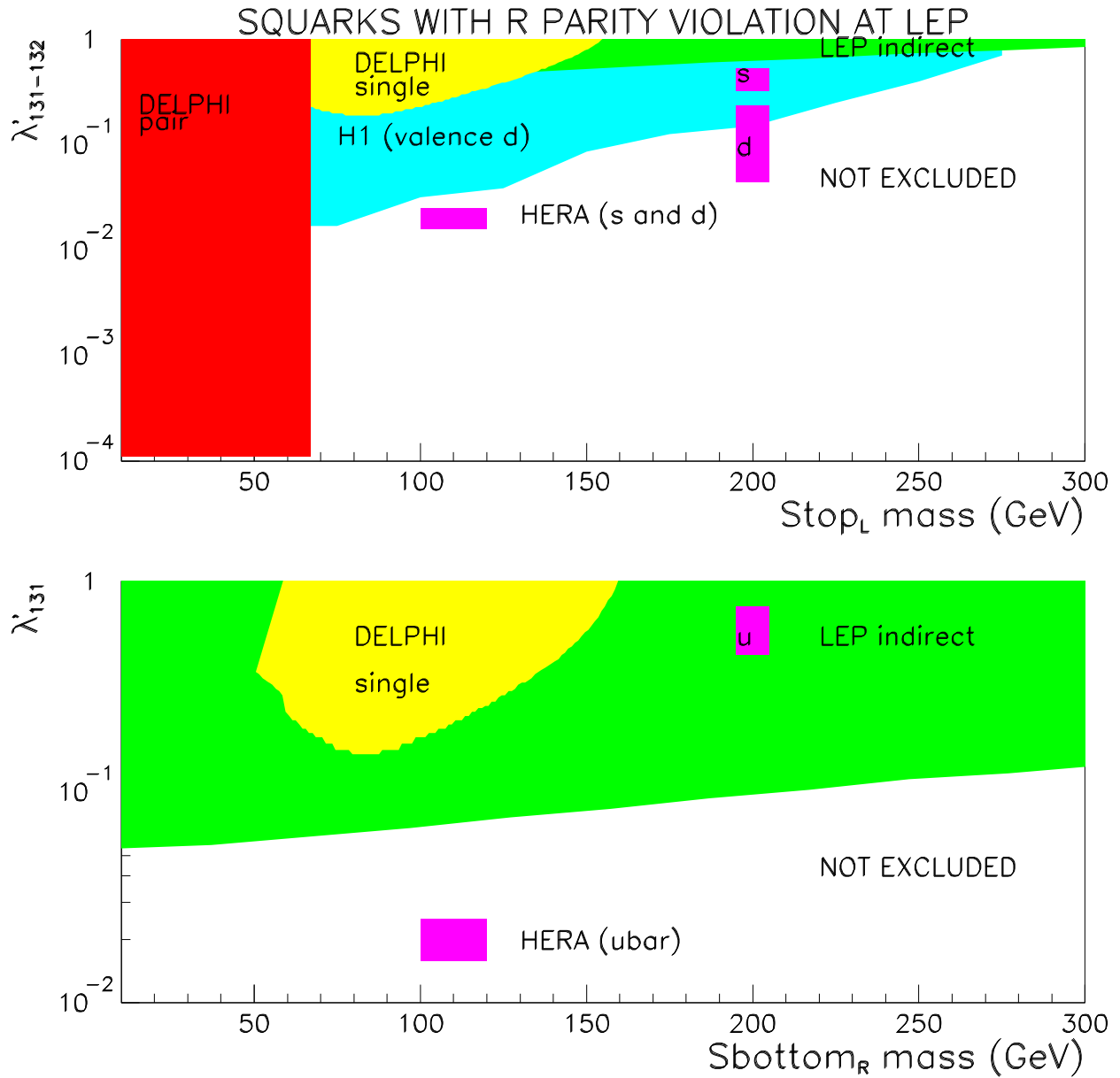

**Figure 13:** Exclusion domain in the  $\lambda'$  versus  $m_{\tilde{q}}$  plane.

## 6.2 Effects of the $R$ -parity violating couplings in the single production

Estimates for single production of a neutralino (with a neutrino), a chargino (with a charged lepton), a resonant sneutrino, all involving  $\lambda_{ijk}$  couplings, have been given in section 4. Single production of a squark in  $\gamma e$  interactions can also occur in  $e^+e^-$  collisions i.e. through the interaction of a quark from a resolved  $\gamma$  radiated by one of the incoming particle ( $e^+$  or  $e^-$ ) with the other incoming particle, involving  $\lambda'_{ijk}$  couplings as shown in figure 14. The striking differences with the above pair production are that in this single production the  $\lambda'$  directly intervene in the expression of the cross-section and that higher squark masses are accessible. In this

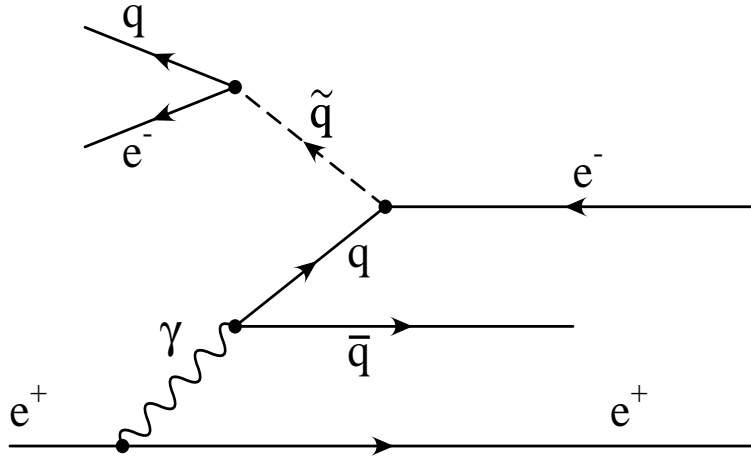

Figure 14: Single squark production

case as well, the direct decay gives a signature of a single lepton opposite a hadronic jet with a resonant mass or missing energy and a hadronic jet; the indirect decay (not present in figure 14) gives a signature of a jet opposite to a two other jets and a lepton or 2 jets and missing energy coming from  $\tilde{\chi}_1^0$  decay via  $\lambda'_{ijk}$  couplings.

This effect has also been searched for experimentally at LEP and no evidence have been found for its occurrence in the 1997 data from the LEP experiments and exclusion domains in a  $\lambda'$  coupling and squark mass plane has been derived as shown for example in figure 13 (indicated by DELPHI single).

## 6.3 Indirect effects of the $R$ -parity $\lambda'$ violating couplings in $e^+e^-$ colliders

The t-channel exchange can in principle give access to squark masses well beyond the kinematical limits. Deviations of the SM cross sections for  $e^+e^- \rightarrow q\bar{q}$  processes depend on the mass and type i.e. u or d, of the exchanged squark and on the  $\lambda'$  couplings. No deviation has been observed in 1997 LEP data and exclusion domains in a  $\lambda'$  coupling and squark mass plane have been derived as shown in figure 13 (indicated by LEP indirect). The relevant exclusion domain derived from the H1 collaboration is also shown in this figure (indicated by H1(valence d) as well as the bands, indicated by u,d,s which would have been relevant for the so called HERA anomaly found in 1997 with the pre-1997 HERA data.

The LEP collider has taken data in 1997 and will continue to take data until year 2000 thus allowing to pursue the search for these  $R_p$  effects. In the next section, a study of some of these  $R_p$  effects is described assuming that the year 2000 scenario will be  $\sqrt{s} = 200$  GeV, with a high luminosity around  $200 \text{ pb}^{-1}$  per experiment.

## 6.4 $R$ -parity scenario at LEP2, at $\sqrt{s} = 200$ GeV, with a high luminosity

All the results of  $R$ -parity violating searches obtained until now show no evidence for a  $R_p$  signal; they are in agreement with the Standard Model expectations. In case of pair production studies, they are used to constrain



domains of the MSSM parameter space and to derive limits on the mass of supersymmetric particles. In this section, the possibility of a run at  $\sqrt{s} = 200$  GeV with an integrated luminosity of  $200 \text{ pb}^{-1}$  per experiment is the basis to evaluate reachable limits on gaugino masses in the hypothesis of no discovery of  $R$ -parity violating sparticle decay. Though it exists 3 terms in the  $\mathcal{R}_p$  superpotential, we consider here only the  $\lambda_{ijk} L_i L_j \bar{E}_k$  term.

### 6.4.1 Pair production of gauginos

The appropriate MSSM parameters to consider in this study are  $\tan\beta$ ,  $m_0$ ,  $M_2$ ,  $\mu$ ; they are scanned over the ranges :  $1 < \tan\beta \leq 30$ ,  $20 \text{ GeV}/c^2 \leq m_0 \leq 500 \text{ GeV}/c^2$ ,  $0 \leq M_2 \leq 400 \text{ GeV}/c^2$ ,  $-200 \text{ GeV}/c^2 \leq \mu \leq 200 \text{ GeV}/c^2$ . Depending on the parameter values, the cross sections at  $\sqrt{s} = 200$  GeV vary typically from 0.1 to 10 pb. If no  $\mathcal{R}_p$  signal is observed, it is possible to rule out some regions in the MSSM parameter space. It is usual to present excluded regions in the  $(\mu, M_2)$  plane for different values of  $\tan\beta$  and  $m_0$ .

In gaugino pair production several processes leading to the same type of final states have a non negligible cross sections. In figure 6.4.1, the area where the  $\tilde{\chi}_1^0 \tilde{\chi}_1^0$ ,  $\tilde{\chi}_2^0 \tilde{\chi}_1^0$  and  $\tilde{\chi}_1^+ \tilde{\chi}_1^-$  cross sections are above 0.3 pb are presented in the  $(\mu, M_2)$  plane for  $\tan\beta = 1.5$ ,  $m_0 = 90$ , and  $\sqrt{s} = 184$  GeV. With  $\sigma_{MSSM} = 0.3 \text{ pb}$ , and  $\mathcal{L} \simeq 50 \text{ pb}^{-1}$ , 15 events are produced, and a 30% efficiency leads to 4-5 events to be detected. As we can see from this plot, regions where the  $\tilde{\chi}_1^0 \tilde{\chi}_1^0$  cross section is too low can be excluded by looking for the  $\tilde{\chi}_1^+ \tilde{\chi}_1^-$  (or  $\tilde{\chi}_2^0 \tilde{\chi}_1^0$ ) processes, provided their production cross section is high enough. Therefore, one has to perform an analysis sensitive to most of the possible final states occurring in the  $\tilde{\chi}_1^0 \tilde{\chi}_1^0$ ,  $\tilde{\chi}_2^0 \tilde{\chi}_1^0$  and  $\tilde{\chi}_1^+ \tilde{\chi}_1^-$  production.

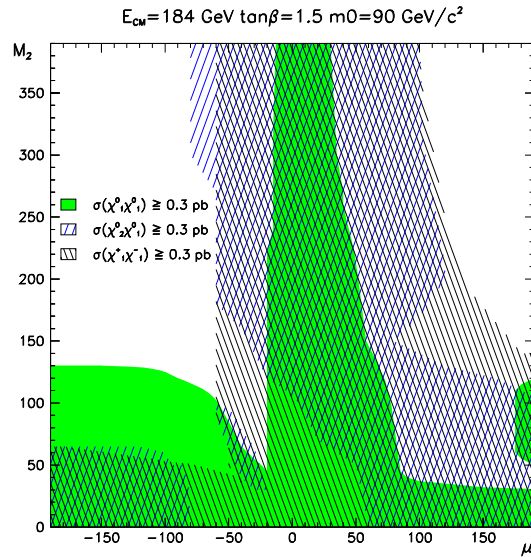

**Figure 15:** Gaugino cross sections in the  $(\mu, M_2)$  plane for  $\tan\beta = 1.5$ ,  $m_0 = 90 \text{ GeV}/c^2$  and  $\sqrt{s} = 184 \text{ GeV}$ ; in the dark grey area  $\sigma(e^+e^- \rightarrow \tilde{\chi}_1^0 \tilde{\chi}_1^0) > 0.3 \text{ pb}$ , in the hatched area  $\sigma(e^+e^- \rightarrow \tilde{\chi}_2^0 \tilde{\chi}_1^0) > 0.3 \text{ pb}$  and/or  $\sigma(e^+e^- \rightarrow \tilde{\chi}_1^+ \tilde{\chi}_1^-) > 0.3 \text{ pb}$ .

### 6.4.2 Hypothesis on the $R$ -parity violating couplings

In case of pair production of supersymmetric particles,  $R_p$  is conserved at the production vertex; the cross section does not depend on the  $\mathcal{R}_p$  couplings. On the contrary, the  $\mathcal{R}_p$  decay width depends on the  $\lambda$  coupling strength, which then determines the mean decay length of the LSP [10, 14]. Searching for the sparticles with the hypothesis that their lifetimes is negligible leads to  $\lambda \geq 10^{-5} - 10^{-6}$  in case of gauginos, which is below the upper limits derived from Standard Model processes [13, 17, 48]. The most stringent upper bound on the  $\lambda_{ijk}$  couplings is the one applied to  $\lambda_{133}$  [16]:

$$\lambda_{133} < 0.003 \frac{M_{\tilde{t}_1}}{100 \text{ GeV}/c^2}$$

which is over the sensitivity limit. A LSP with a low mass, and then with a high boost, can escape the detection before decaying. So the assumption of a negligible LSP lifetime restricts the sensitivity of this study to  $M_{LSP} \gtrsim 10$  GeV, when considering the lowest upper bound on the couplings.

To perform the search, it is also assumed that only one among the 45 possible couplings is dominant. According to the considered dominant coupling, the decay of the pair-produced gauginos and sfermions will lead to different topologies, which could be purely leptonic (from 2 to 8 leptons, with or without missing energy), purely hadronic (from 2 to 10 jets), or mixed (leptons + jets). The analyses performed by the LEP experiments are aimed to select specific topologies coming from the large number of possibilities of final states.

### 6.4.3 Direct and indirect decays of gauginos

In case of a dominant  $\lambda_{ijk}$  coupling, the sleptons couple to the leptons, and the gauginos decay into charged leptons and neutrinos. The decay of the lightest neutralino leads to one neutrino and two charged leptons (figure 8, upper part). The heavier neutralinos and the charginos, depending on their mass difference with  $\tilde{\chi}_1^0$ , can either decay directly into 3 standard fermions, or decay to  $\tilde{\chi}_1^0$ , via for example virtual  $Z$  or  $W$ , as illustrated on figure 8, lower part. Note that, even if the  $\lambda$  couplings lead to purely leptonic decay modes of the lightest neutralino, in case of chargino and heavier neutralino, the final state may contain some hadronic activity.

Decay types and branching ratios depend on the set of MSSM parameters and on the value of the considered  $\lambda_{ijk}$  coupling. In case of pair production of gaugino, the final states listed in table 2 have to be considered.

### 6.4.4 Expected limits at $\sqrt{s} = 200$ GeV

**We start from an example: search at  $\sqrt{s} = 183$  GeV**

As already mentioned, it is generally assumed that only one coupling is dominant, and to be conservative when establishing limits, the results are derived from the study done with the coupling giving the lowest detection efficiency. For example, in case of  $\lambda_{ijk}$  coupling, if the  $\lambda_{133}$  is dominant, the leptons from  $\tilde{R}_p$  decay are mainly taus, and electrons. This case should have the worst efficiency due to the presence of several  $\tau$  in the final state, and will give the most conservative limits. To determine efficiencies, events with  $\tilde{R}_p$  decay of gauginos are produced using the SUSYGEN generator [129] coupled to the detector simulation program. For example, considering the DELPHI experiment [128], selection efficiencies in all the considered  $(\mu, M_2)$  planes are in the range 22-34% for  $\tilde{\chi}_1^0$  pair produced, 20-37% for  $\tilde{\chi}_1^+ \tilde{\chi}_1^-$ , and 20-25% for  $\tilde{\chi}_2^0 \tilde{\chi}_1^0$ . The background is mainly due to  $e^+e^- \rightarrow W^+W^-$  and  $e^+e^- \rightarrow Z^0Z^0$  events. Since the results of the analyses are in agreement with the Standard Model expectation, regions in the studied MSSM parameter space are excluded, which allows to derive a lower limit on neutralino mass.

**The high energy, high luminosity case.**

In order to evaluate the limits reachable if  $200 \text{ pb}^{-1}$  of  $e^+e^-$  events are collected at 200 GeV, several parameters have to be considered.

- *The production cross sections at 200 GeV:* they are determined with the SUSYGEN program. There is no serious variation of the cross sections in the range of MSSM parameters considered between 184 and 200 GeV.
- *The luminosity:* compared to the luminosity accumulated in 1997, there is a factor of  $\sim 4$  increase, which is favorable to extend the excluded areas.
- *The Standard Model processes:* in most of the  $\tilde{R}_p$  analyses, the main background contributions come from the four-fermion processes and the  $Z^0\gamma$  events. From 184 to 200 GeV, the cross sections of the four-fermion processes increase [130], especially the  $e^+e^- \rightarrow Z^0Z^0$  cross section; the  $e^+e^- \rightarrow Z^0\gamma$  cross section decreases.
- *The selection efficiencies:* it is assumed that the selection efficiencies will be in the same range than those obtained at  $\sqrt{s} = 184$  GeV.

The processes contributing to the selected final states are combined to give the exclusion contours at 95% C.L. in the  $(\mu, M_2)$  plane. The maximum number of signal events in presence of background is given by the standard formula [34]. All the points in the  $(\mu, M_2)$  plane which satisfy the condition:

$$N \leq (\sum_{i=1}^3 \epsilon_i \sigma_i) \mathcal{L} \quad \text{where } i \text{ runs for the contributing processes } (\tilde{\chi}_1^0 \tilde{\chi}_1^0, \tilde{\chi}_2^0 \tilde{\chi}_1^0, \tilde{\chi}_1^+ \tilde{\chi}_1^-)$$

are excluded at 95% C.L.

Instead of considering separately the number of observed events and the number of expected background events one could obtained at a high energy run, we consider several values for the 95% C.L. upper limit on

$\sqrt{s} = 200 \text{ GeV}, L = 200 \text{ pb}^{-1}$

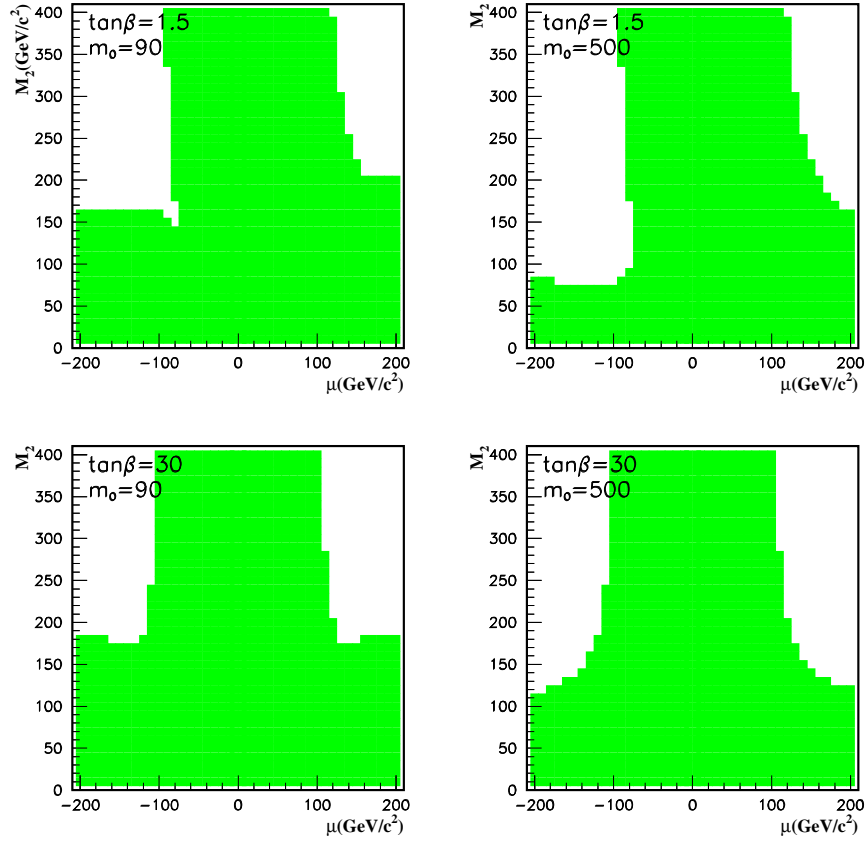

**Figure 16:** Regions in  $(\mu, M_2)$  plane excluded at 95 % C.L. for two values of  $\tan\beta$  and two values of  $m_0$ . The exclusion area are obtained with the hypothesis that the selection efficiencies are 30%, 20% and 25% for  $\tilde{\chi}_1^0\tilde{\chi}_1^0$ ,  $\tilde{\chi}_2^0\tilde{\chi}_1^0$ , and  $\tilde{\chi}_1^+\tilde{\chi}_1^-$  respectively, and that the 95%C.L. upper limit on the number of signal events is 5.

the number of signal event ( $N_{95} = 3, 5, 10, 15$ ). We consider also several sets of efficiencies for the 3 considered processes. The exclusion area obtained with the hypothesis that the selection efficiencies are 30%, 20% and 25% for  $\tilde{\chi}_1^0\tilde{\chi}_1^0$ ,  $\tilde{\chi}_2^0\tilde{\chi}_1^0$ , and  $\tilde{\chi}_1^+\tilde{\chi}_1^-$  respectively, and that the 95%C.L. upper limit on the number of signal events is equal to 5, are presented in figure 16, for two values of  $m_0$  (90 and 500  $\text{GeV}/c^2$ ) and two values of  $\tan\beta$  (1.5, 30).

The results can be translated into a lower limit on  $\tilde{\chi}_1^0$  mass, as a function of  $\tan\beta$ . In order to obtain this limit, for each value of  $\tan\beta$  we scanned over  $m_0$  values from 20 up to 500  $\text{GeV}/c^2$  and we determined the limit on the  $\tilde{\chi}_1^0$  mass. This limit decreases as  $m_0$  increases, then it becomes constant for  $m_0 > 200\text{-}300 \text{ GeV}/c^2$ . So, at a given  $\tan\beta$ , the lowest mass limit is given by the highest value of  $m_0$ . Considering this, we can set a mass limit independantly of the choice of  $m_0$ . This procedure has been repeated for different sets of efficiency and  $N_{95}$  values. At  $m_0=500 \text{ GeV}/c^2$ , the lowest  $\tilde{\chi}_1^0$  mass not excluded is in an area where the dominant contribution comes from the chargino pair production. Moreover, since the cross section of this process rapidly increases, the neutralino mass limit is not very sensitive to the efficiency and  $N_{95}$  variations (figure 17).

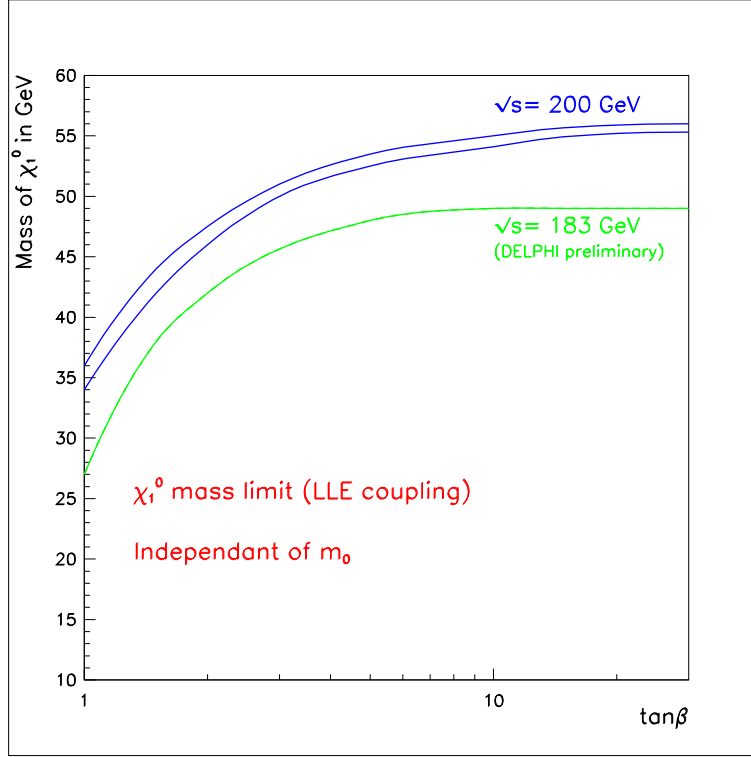

**Figure 17:**  $\tilde{\chi}_1^0$  mass limit as a function of  $\tan\beta$ . The light grey curve presents the preliminary current limit obtained by DELPHI with the 1997 data. The 2 dark grey curves show the range for the expected  $\tilde{\chi}_1^0$  mass limit in case of  $200 \text{ pb}^{-1}$  collected at  $\sqrt{s} = 200 \text{ GeV}$ : the upper curve is obtained assuming  $N_{95} = 5$ ,  $\epsilon_{\tilde{\chi}_1^0 \tilde{\chi}_1^0} = 30\%$ ,  $\epsilon_{\tilde{\chi}_2^0 \tilde{\chi}_1^0} = 20\%$ ,  $\epsilon_{\tilde{\chi}_1^+ \tilde{\chi}_1^-} = 25\%$ ; the lower curve is obtained assuming  $N_{95} = 15$ ,  $\epsilon_{\tilde{\chi}_1^0 \tilde{\chi}_1^0} = 30\%$ ,  $\epsilon_{\tilde{\chi}_2^0 \tilde{\chi}_1^0} = 25\%$ ,  $\epsilon_{\tilde{\chi}_1^+ \tilde{\chi}_1^-} = 15\%$

## 6.5 Conclusion

The LEP is now running at  $\sqrt{s} = 189 \text{ GeV}$ , and an integrated luminosity of around  $150 \text{ pb}^{-1}$  is expected. In this case, combining 1997 and 1998 data, and in the hypothesis that no evidence for  $R_p$  is found in the 1998 data, the limits on the  $\tilde{\chi}_1^0$  mass will be almost the same as those expected at  $\sqrt{s} = 200 \text{ GeV}$ . Since the luminosity plays a major role in the  $\tilde{\chi}_1^0$  mass limit determination, we will obtain a higher limit by combining the data taken in 1997 to 2000, at the different center of mass energies from 183 to 200 GeV. The high energy run will allow explore the chargino mass up to a value close to the kinematical limit and to explore sfermions masses beyond the present limits. All these  $R_p$  effects may also be search for within the future projects of higher energies (center of mass energies of 500 GeV or more) linear leptonic colliders.

## 7 $R$ -parity violation at LHC

The search for SUSY at hadron colliders has been mainly investigated within the minimal supergravity model [131]. This leads to the canonical missing  $E_T$  signature which follows from the  $R$ -parity conservation assumption. However,  $R$ -parity need not to be conserved in supersymmetric extensions of the Standard Model (see introduction). Therefore, it is important to consider the new phenomenology associated with  $R$ -parity broken models, in order to design LHC experiments the most efficient way to search for new physics. Studies of  $R$ -parity violation can be approached by considering two extreme cases :

- $R_p$  couplings are dominant with respect to the gauge couplings. Then, the running of these new Yukawa couplings has to be taken into account into RGE evolution. The mass spectrum and branching ratio of the supersymmetric particle could be affected depending on the magnitude of the couplings. In that case, one generally searches for specific processes involving the couplings at the production.
- $R_p$  couplings are small enough, so that the usual decay pattern of sparticles remains unchanged. Then, mSUGRA predictions are still valid, the only difference coming from the decay of the LSP.

In the results described below, we have followed the second approach. Other simplifying assumptions have been considered : i) The mSUGRA framework is still used in order to predict mass spectrum and branching ratio. In a large region of parameters, the LSP is the  $\tilde{\chi}_1^0$ . We restrict our conclusions to these regions. ii) Among the  $R_p$  couplings, only one dominates. The theoretical motivation being that in analogy with the Standard Model, a hierarchical structure is also expected between the Yukawa couplings violating  $R$ -parity. In the following, we have treated more specifically the purely leptonic decays of equ.(48). Assuming slepton mass degeneracy, the branching ratio in each of the four final states of equ.(48) is 25% independent of the  $\tilde{\chi}_1^0$  composition.

$$\tilde{\chi}_1^0 \xrightarrow{\lambda_{ijk}} \begin{cases} \bar{\nu}_i e_j^+ e_k^- \\ e_i^+ \bar{\nu}_j e_k^- \\ \nu_i e_j^- e_k^+ \\ e_i^- \nu_j e_k^+ \end{cases} \quad (48)$$

In table 3, we display the  $\tilde{\chi}_1^0$  branching ratio in 0, 1 or 2 leptons according to the  $\lambda_{ijk}$  selected. The mean number of additional isolated leptons varies between 1 and 2 per  $\tilde{\chi}_1^0$  decay. The two extreme cases correspond to  $\lambda_{133} \neq 0$  (or equivalently  $\lambda_{233} \neq 0$ ) and  $\lambda_{121} \neq 0$  (or equivalently  $\lambda_{122} \neq 0$ ). For  $\lambda_{121} \neq 0$ , the gain is obvious

$\lambda_{ijk}$ $ijk$	Decay channel	Fraction of leptons			Mean number of	
		0l	1l	2l	$\langle l \rangle$	$\langle \nu \rangle$
121	$e^- \nu_\mu e^+ + \nu_e \mu^- e^+ + c.c$	0%	0%	100%	2.0	1.0
122	$e^- \nu_\mu \mu^+ + \nu_e \mu^- \mu^+ + c.c$	0%	0%	100%	2.0	1.0
123	$e^- \nu_\mu \tau^+ + \nu_e \mu^- \tau^+ + c.c$	0%	65%	35%	1.3	2.3
131	$e^- \nu_\tau e^+ + \nu_e \tau^- e^+ + c.c$	0%	32.5%	67.5%	1.7	1.7
132	$e^- \nu_\tau \mu^+ + \nu_e \tau^- \mu^+ + c.c$	0%	32.5%	67.5%	1.7	1.7
133	$e^- \nu_\tau \tau^+ + \nu_e \tau^- \tau^+ + c.c$	21.1%	55.3%	23.6%	1.0	3.0
231	$\mu^- \nu_\tau e^+ + \nu_\mu \tau^- e^+ + c.c$	0%	32.5%	67.5%	1.7	1.7
232	$\mu^- \nu_\tau \mu^+ + \nu_\mu \tau^- \mu^+ + c.c$	0%	32.5%	67.5%	1.7	1.7
233	$\mu^- \nu_\tau \tau^+ + \nu_\mu \tau^- \tau^+ + c.c$	21.1%	55.3%	23.6%	1.0	3.0

**Table 3:**  $\tilde{\chi}_1^0$  decay channels and branching ratio in 0, 1 and 2 leptons ( $e$  or  $\mu$ ).  $BR(\tau^- \rightarrow e^- \bar{\nu}_e \nu_\tau) = BR(\tau^- \rightarrow \mu^- \bar{\nu}_\mu \nu_\tau) = 17.5\%$  has been used.

: there are always 2 additional isolated leptons per  $\tilde{\chi}_1^0$  decay. For  $\lambda_{133} \neq 0$ , however, due to the branching ratio of the  $\tau$  in hadronic modes, in 21.1% of the cases, there are no additional leptons. In order to cover most of event's topologies, we have studied these two extreme cases :  $\lambda_{121} = 0.05$  and  $\lambda_{233} = 0.06$ . The magnitude of the couplings is taken from the present limit 2. In order to study the  $\tilde{\chi}_1^0$  decay, one has to provide the decay width of the 3 body process (via virtual  $\tilde{f}$ ) in each final states. The details of the calculation is based on the theoretical paper [144] and is given in [146]. It takes into account effects due to sfermion mixing without

neglecting final states masses. However, these effects are small for the pure leptonic decay of the neutralino and a branching ratio of 25% in each of the 4 possible final states remains an excellent approximation (this is not true for  $\lambda'$  or  $\lambda''$  coupling). As an illustration, in figure 18, the neutralino lifetime is plotted in the  $m_0 - m_{1/2}$

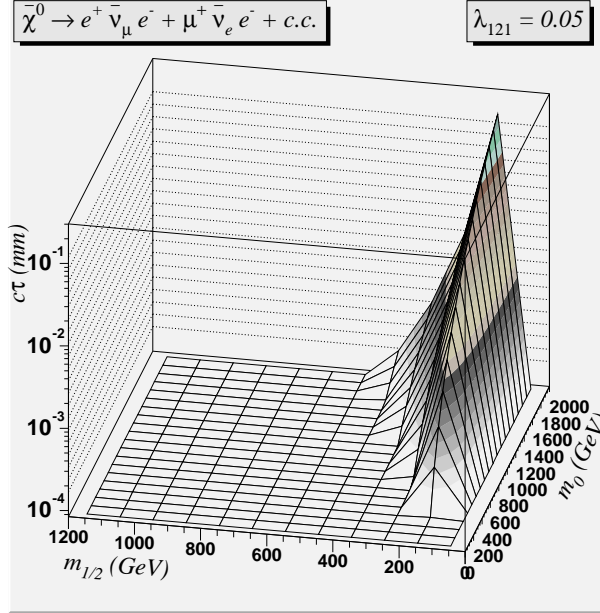

**Figure 18:** Neutralino  $c\tau$  as function of  $m_0$  and  $m_{1/2}$ . Parameters used are  $\lambda_{121} = 0.05$ ,  $A_0 = 0$ ,  $\mu < 0$  and  $\tan \beta = 2.0$ .

plane. The parameters used are  $\lambda_{121} = 0.05$ ,  $A_0 = 0$ ,  $\mu < 0$  and  $\tan \beta = 2.0$ . At first approximation, the lifetime varies as  $m_{\tilde{f}}^4/m_{\tilde{\chi}_1^0}^5$  (usual 3-body decay). Therefore, the lifetime reaches its maximum for large values of  $m_0$  and small  $m_{1/2}$  since  $m_{\tilde{f}}$  and  $m_{\tilde{\chi}_1^0}$  scale respectively as  $m_0$  and  $m_{1/2}$ .

## 7.1 ATLAS discovery potential

The ATLAS Collaboration has demonstrated earlier in the framework of the Supergravity (SUGRA) Model and assuming  $R$ -parity conservation that Supersymmetry (SUSY) can be ruled out experimentally at the LHC, for masses less than about 1 TeV, if it is not realized in Nature. On the other hand it was found that if SUSY exists, one can not only discover it experimentally, but one can also constrain the model and determine its parameters with high precision (see [132]- [136]).

If  $R$ -parity is not conserved, some SUSY signals disappear (or at least become weaker), e.g. the missing energy will be reduced since in this case the lightest supersymmetric particle (LSP) is allowed to decay. On the other hand, the same decay would enable the experimental determination of the mass of the LSP and thus would provide more information on the parameters of the SUGRA model. It is therefore important to repeat the previous study on SUSY to see how the above mentioned results are modified in case of the violation of the  $R$ -parity. This study has been carried out assuming that one of the  $\lambda_{ijk}$  ( $i, j, k = 1, 2, 3$ ) coupling is nonzero. Inclusive and exclusive reactions in the LHC points 1, 3 and 5 of the earlier study (see [132]) have been considered.

Since there was no existing generator which produced events in hadron colliders *and* violated  $R$ -parity, ISAJET [137] and SUSYGEN [129] have been merged. After detailed testing this new program [138] has been used to produce over 1 million of events which were subsequently analysed. The response of the ATLAS detector has been simulated by ATLFAST [139]. The event selection will be described in a forthcoming report [140]. The Standard Model background, mainly  $t\bar{t}$  and  $W/Z$  pair production has been generated by ISAJET [137].

The study of the inclusive reactions confirmed the above mentioned result in case of  $R$ -parity conservation: if SUSY is realized in Nature it can be safely discovered by ATLAS in the complete parameter space of interest. This is demonstrated in case of the non-vanishing  $\lambda_{123}$  coupling in figure 19.

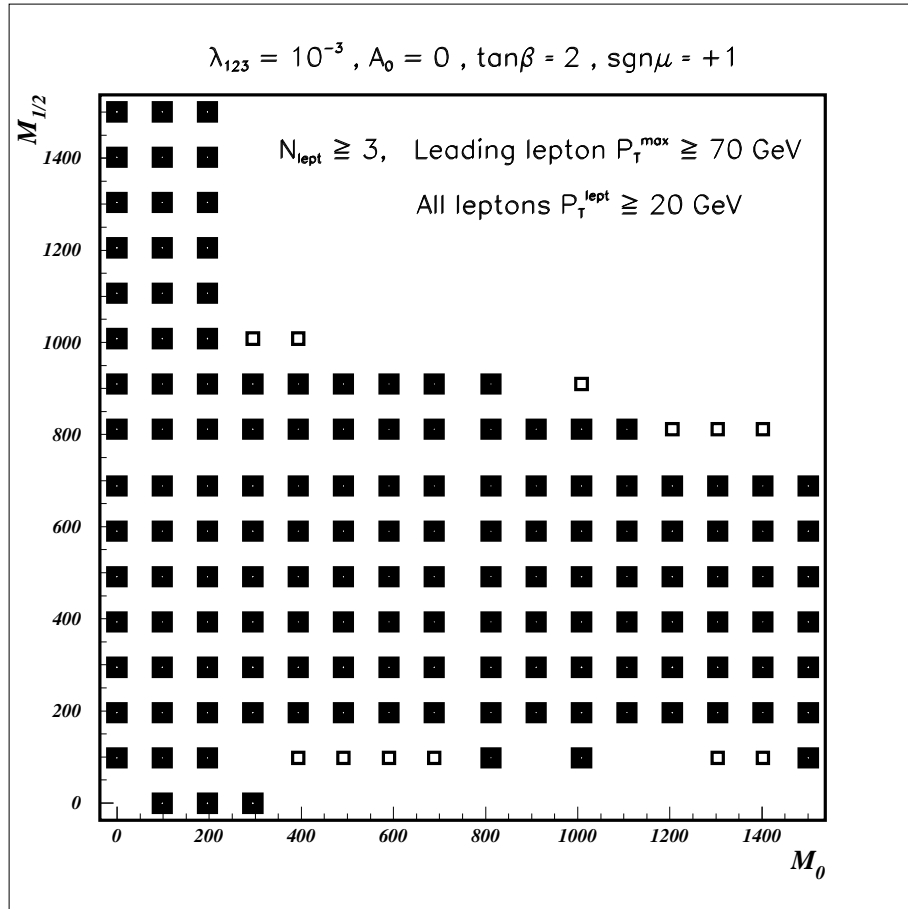

**Figure 19:** ATLAS expected excluded region in the  $M_{1/2}$  vs.  $M_0$  plane for 1 year of LHC low luminosity run. Boxes correspond to SUGRA signals above the Standard Model with more than 5 (full boxes) or less than 5 (empty boxes) st. deviations

It was also found that for most of the  $\lambda_{ijk}$  couplings (whose values have been chosen to be  $10^{-3}$  taking into account existing limits and considering event topologies without displaced vertices), the parameters of the SUGRA model can be determined at least with the same precision than in case when  $R$ -parity is conserved [140], [141]. In figure 20 one can see an example of the reconstruction of the gauginos in the LHC point 1 for  $\lambda_{122} = 10^{-3}$ .

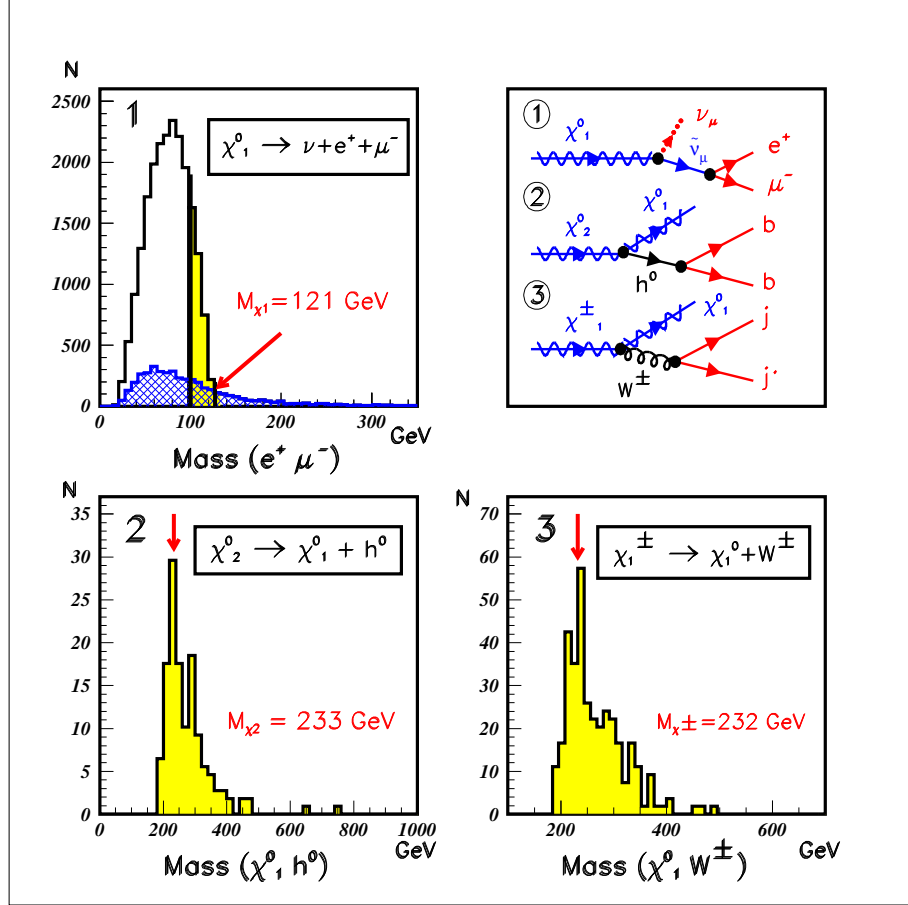

**Figure 20:** ATLAS reconstruction of gauginos: the endpoint of the distribution in inlet 1 provides the mass of the  $\chi_1^0$ . The combination of the  $\chi_1^0$  with the  $h^0$  shows the mass peak of the  $\chi_2^0$  (inlet 2). Finally the combination of the  $\chi_1^0$  with the  $W^\pm$  shows the mass peak of the  $\chi_1^\pm$  (inlet 3). The events around the endpoint of inlet 1 (indicated by the dotted area) are used to reconstruct the gauginos shown in inlets 2 and 3. The hatched area in inlet 1 corresponds to the combinatorial background from SUSY particles other than the  $\chi_1^0$ .

These results have been presented in several meetings of the ATLAS collaboration and of the GdR SUSY.

## 7.2 CMS discovery potential

### 7.2.1 SUSY signal simulation

The analysis is performed within the framework of the minimal supergravity model (mSUGRA) where only five parameters need to be specified :  $m_0$ ,  $m_{1/2}$ ,  $A_0$ ,  $\tan\beta$  and  $sign(\mu)$ . PYTHIA 6.1 [142] including supersymmetric processes [143] has been used with its default structure function (CTEQ2L) to generate both supersymmetric signals and Standard Model background. PYTHIA allows to generate either MSSM supersymmetric models (the



user providing the mass spectrum) or mSUGRA models. For mSUGRA, the mass spectrum at the electroweak symmetry breaking is computed from the parameters specified at the GUT scale, using approximate analytic formulae. The difference with the exact numerical resolution has been checked to lie within 10%. An obvious interesting feature of PYTHIA is the possibility to use at hadron colliders, the initial and final state radiation and fragmentation models of PYTHIA/JETSET. In the present version of PYTHIA  $R$ -parity violation is not implemented. Therefore an interface between PYTHIA and the theoretical calculation of the  $\tilde{\chi}_1^0$  decay width described in the previous section has been incorporated [146].

SUSY signals are generated in the  $m_0 - m_{1/2}$  plane with the other parameters set to  $\mu < 0$ ,  $A_0 = 0$  and  $\tan\beta = 2.0$ . We consider only squarks and gluinos production ( $pp \rightarrow \tilde{g}\tilde{g}, \tilde{g}\tilde{q}, \tilde{q}\tilde{q}$ ) which is the dominant source of SUSY events at the LHC. The production of isolated leptons arises from cascade decays of squarks and gluinos and from the  $\tilde{\chi}_1^0$  decay.

## 7.2.2 SM background simulation

The Standard Model processes generated are those which produced isolated leptons. We have considered : i)  $t\bar{t}$  production where leptons may arise from  $t \rightarrow bW$  followed by  $W \rightarrow l\bar{\nu}$ . ii) single boson production ( $Z/\gamma^*, W$ ). iii) double boson production ( $ZZ, ZW, WW$ ). iiiii) QCD jet production (where leptons arise from heavy flavors). Additional jets come from initial and final state QCD radiations using parton showers approach.

## 7.2.3 CMS detector simulation

We use the fast non-geant simulation package CMSJET 4.3 [145]. It is well adapted in view of the huge statistic needed. The main features of CMSJET relevant to this analysis are :

- Charged particles are tracked in a 4 T magnetic field with 100% reconstruction efficiency per track.
- ECAL calorimeter up to  $|\eta| = 2.6$  with a granularity of  $\Delta\phi \times \Delta\eta = 0.0145 \times 0.0145$ . The energy resolution is parametrized as  $\Delta E/E = 5\%/\sqrt{E} \oplus 0.5\%$ .
- HCAL calorimeter up to  $|\eta| = 3$  and  $|\eta| = 5$  in the very forward. The granularity is  $\Delta\phi \times \Delta\eta = 0.087 \times 0.087$  (for  $|\eta| < 2.3$ ) and the energy resolution depends on  $\eta$  (equals to  $82\%\sqrt{E} \oplus 6.5\%$  at  $\eta = 0$ ).
- Lepton's momenta are smeared (both  $\mu$  and  $e$ ) according to parametrization obtained from detailed GEANT simulations with an angular coverage going up to  $|\eta| < 2.4$ .

## 7.2.4 Events selection

In the presence of  $R$ -parity violation via leptonic couplings ( $\lambda$  and  $\lambda'$ ), an excess of isolated leptons is expected coming from the  $\tilde{\chi}_1^0$  decay. Even if a few amount of  $\cancel{E}_T$  is still expected (due mainly to neutrinos from  $\tilde{\chi}_1^0$  decay), one cannot use any longer this criteria without cutting too much signal. Therefore, severe constraints are required on isolated leptons.

The lepton isolation is defined by : i) no charged particle with  $p_T > 2 \text{ GeV}/c$  in a cone radius  $R = \sqrt{\Delta\eta^2 + \Delta\phi^2} = 0.3$  about the lepton direction. This criteria mainly suppresses the background from  $t\bar{t}$ . ii) The transverse energy deposited in the calorimeter in a cone radius  $R = 0.3$  about the lepton direction should not exceed 10% of the lepton transverse energy.

Then, events satisfying the following cuts are selected : i) At least 3 isolated leptons with  $p_T > 20 \text{ GeV}/c$  for  $e$  and  $10 \text{ GeV}/c$  for  $\mu$ , and  $|\eta_l| < 2.4$ . ii) At least 2 jets with  $p_T > 50 \text{ GeV}/c$  and  $|\eta_{jet}| < 4.5$ .

The invariant mass  $m_{l+l-}$  is then reconstructed for opposite sign leptons. When several combinations per event are allowed, the one with the minimal angular separation is chosen. A significant deviation from the Standard Model spectrum provides evidence for SUSY. Moreover, the specific shape of the mass distribution with its sharp edge, allows to measure directly  $m_{\tilde{\chi}_1^0}$ . This measurement could then be used to determine the mSUGRA parameters. In figure 21, an example is shown for  $\lambda_{121} = 0.05$ ,  $m_0 = 1000$ ,  $m_{12} = 500$ ,  $\tan\beta = 2$ ,  $A_0 = 0$  and  $\mu < 0$ .

## 7.2.5 Results and conclusion

We define the signal significance as  $N_S/\sqrt{N_S + N_B}$  where  $N_S$  and  $N_B$  are respectively the number of signal and background events. The mSUGRA plan is scanned and for each points the signal significance is computed. The  $5\sigma$  contour is then determined and the result is shown in figure 22 for  $\lambda_{121} = 0.05$  (continuous curve) and

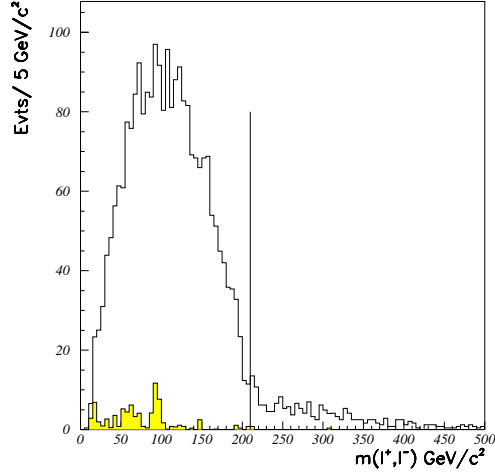

**Figure 21:** CMS dilepton invariant mass distribution for  $\lambda_{121} = 0.05$ ,  $m_0 = 1000$ ,  $m_{12} = 500$ ,  $\tan\beta = 2$ ,  $A_0 = 0$  and  $\mu < 0$ . The shaded area corresponds to the SM background. The straight line indicates the  $\tilde{\chi}_1^0$  mass equal to 210  $\text{GeV}/c^2$ . Signal and background are normalized to an integrated luminosity of  $10^4 \text{ pb}^{-1}$ .

$\lambda_{233} = 0.06$  (dotted curve) with an integrated luminosity of  $10^4 \text{ pb}^{-1}$ . Since these couplings correspond to the two extreme scenarii for a pure leptonic decay of  $\tilde{\chi}_1^0$ , the discovery potential for any  $\lambda_{ijk}$  should lie between the two curves. In presence of  $\mathcal{R}_p$ -supersymmetry via any  $\lambda_{ijk}$  terms, with one year at low luminosity ( $10^4 \text{ pb}^{-1}$ ) the maximum gluino mass reach varies from 1.5 to 2.5 TeV depending on  $m_0$  and  $\lambda_{ijk}$  while the squark mass varies from 1.8 to 2.5 TeV. The discovery potential with  $\mathcal{R}_p$ -SUSY is found to be better, or of the same order, than with  $R$ -parity conserved scenarii (in case of pure leptonic decays). More details of this analysis could be found in [146]. Analyses for more pessimistic couplings ( $\lambda'$  and  $\lambda''$ ) are underway.

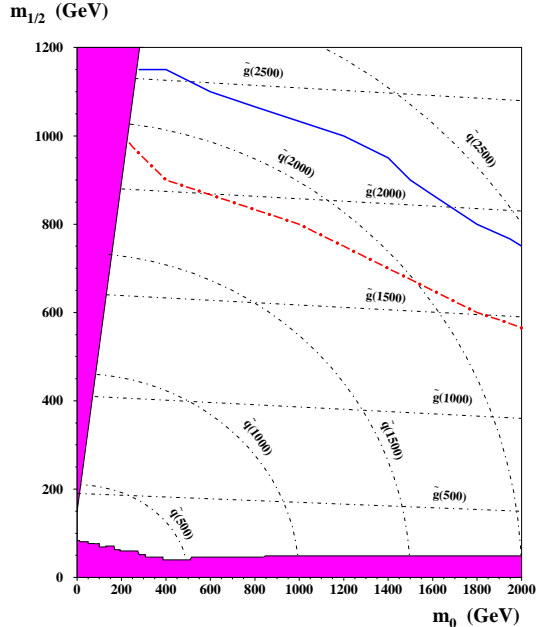

**Figure 22:**  $5\sigma$  discovery potential of CMS in mSUGRA for  $\mu < 0$ ,  $\tan\beta = 2$  and  $A_0 = 0$ . In the region below the black curve a signal of  $\tilde{R}_p$ -supersymmetry via  $\lambda_{121} = 0.05$  would be discovered ( $5\sigma$  for an integrated luminosity of  $10^4 pb^{-1}$ ). The dotted curve corresponds to the discovery potential for a signal of  $\tilde{R}_p$ -supersymmetry via  $\lambda_{233} = 0.06$ . In the shaded regions mSUGRA model is not valid or  $\tilde{\chi}_1^0$  is no longer the LSP.

## 8 Neutrino masses and $R$ -parity violation

Neutrinos are massive in numerous extensions of the Standard Model. In supersymmetric models, three types of contributions to neutrino masses and mixings can be present<sup>6</sup>: (i) neutrino-zino mixing via sneutrino vacuum expectation values [4, 9, 148]; (ii) neutrino-higgsino mixing via bilinear  $R$ -parity violating terms  $\mu_i L_i H_u$  [6, 10]; (iii) fermion-sfermion loops induced by the trilinear  $R$ -parity violating terms  $\lambda_{ijk} L_i L_j \bar{e}_k$  and  $\lambda'_{ijk} L_i Q_j \bar{d}_k$  [6, 12, 149, 26, 54]. These contributions are generally expected to be large, if present, and have to match the experimental limits on neutrino masses

$$m_{\nu_e} < 4.5 \text{ eV} \quad m_{\nu_\mu} < 160 \text{ keV} \quad m_{\nu_\tau} < 23 \text{ MeV} \quad (49)$$

and the cosmological bound on stable, doublet neutrinos,  $\sum_i m_{\nu_i} \leq \mathcal{O}(10 \text{ eV})$ . Note that any of these mechanisms require  $R$ -parity violation, since a sneutrino vev induces  $R$ -parity breaking. Note also that the introduction of a right-handed neutrino is not required; it follows that only Majorana masses are generated:

$$-\frac{1}{2} M_{ij}^\nu \bar{\nu}_{L_i} \nu_{R_j}^c + h.c. \quad (50)$$

where  $\nu_{R_j}^c$  is the  $CP$  conjugate of  $\nu_{L_j}$ , and  $M^\nu$  is a symmetric matrix. The relative rotation between charged lepton and neutrino mass eigenstates defines a lepton mixing matrix, which is the analog of the CKM matrix in the quark sector, and is responsible for neutrino oscillations.

Let us first consider mechanism (i). Since the squared masses of the sneutrinos receive negative contributions from the  $D$ -terms, it is not unlikely that they assume a vev - actually radiative corrections ensure that only the tau sneutrino has a vev. As a result, the tau neutrino mixes with the zino, and we end up with a  $5 \times 5$  neutralino mass matrix. Its diagonalization yields a mass eigenstate which can be identified with a massive tau

<sup>6</sup>Of course, neutrino masses can receive contributions from other (non supersymmetric) mechanisms, such as the well-known seesaw mechanism [147], which involves heavy right-handed neutrinos.

neutrino [36]:

$$m_{\nu_3} = \frac{M_Z^2 (M_1 c_w^2 + M_2 s_w^2) \mu}{M_1 M_2 \mu - M_Z^2 \sin 2\beta (M_1 c_w^2 + M_2 s_w^2)} \left( \frac{\langle \tilde{\nu}_\tau \rangle}{v} \right)^2 \quad (51)$$

where  $c_W \equiv \cos \theta_W$ ,  $s_W \equiv \sin \theta_W$ ,  $v = 174 \text{ GeV}$  and  $M_1, M_2$  are the  $U(1)_Y \times SU(2)_L$  gaugino soft masses. Thus  $m_{\nu_3}$  is typically of the order of the weak scale, unless  $\langle \tilde{\nu}_\tau \rangle \ll v$ . The LEP limit on  $m_{\nu_\tau}$  actually requires  $\langle \tilde{\nu}_\tau \rangle \lesssim 1 \text{ GeV}$ , while if the tau neutrino does not decay quickly enough, the cosmological bound turns into  $\langle \tilde{\nu}_\tau \rangle \lesssim 1 \text{ MeV}$ . Note that if the theory initially preserves  $R$ -parity, it is spontaneously broken by the sneutrino vev, and trilinear couplings  $\lambda_{3jk} L_3 L_j \bar{e}_k$  and  $\lambda'_{3jk} L_3 Q_j \bar{d}_k$  are generated. As will be shown below, this gives rise to nonzero masses and mixings for the electron and muon neutrinos. In addition, if lepton number is a global symmetry of the theory, its spontaneous breaking yields a massless Goldstone boson called Majoron. Energy loss from red giant stars via Majoron emission then leads to the constraint [150]  $\langle \tilde{\nu}_\tau \rangle \lesssim 100 \text{ keV}$ , which would require a large amount of fine-tuning in the scalar potential.

Let us now consider mechanism (ii) (we refer to Ref. [81, 151] for more details). The bilinear terms  $\mu_i L_i H_u$  in the superpotential induce a mixing between the neutral leptons and up higgsino that cannot be completely rotated away in the presence of generic soft terms. Indeed, the sneutrinos acquire vevs together with the Higgs bosons. By redefining the lepton and down Higgs superfields in such a way that only  $H_d$  assumes a vev, one finds that one lepton superfield (say  $L_3$ ) still couples to  $H_u$ . As a consequence, the diagonalization of the neutralino mass matrix yields one massive neutrino [84]:

$$m_{\nu_3} = \frac{M_Z^2 \cos^2 \beta (M_1 c_w^2 + M_2 s_w^2) \mu \cos \xi}{M_1 M_2 \mu \cos \xi - M_Z^2 \sin 2\beta (M_1 c_w^2 + M_2 s_w^2)} \tan^2 \xi \quad (52)$$

where  $\xi$  is the angle between the vectors  $\mathbf{v} = \{v_0 \equiv \langle H_d^0 \rangle; v_i \equiv \langle L_i^0 \rangle\}$  and  $\boldsymbol{\mu} = \{\mu_0 \equiv \mu; \mu_i\}$ ; thus  $m_{\nu_3}$  vanishes in the limit where the  $v_\alpha$  are proportional to the  $\mu_\alpha$ . The factor in front of  $\tan^2 \xi$  is typically of the order of the weak scale; therefore, the LEP limit on  $m_{\nu_\tau}$  requires a strong alignment ( $\sin \xi \ll 1$ ) of the  $v_\alpha$  along the  $\mu_\alpha$ , typically  $\sin \xi \lesssim 10^{-2}$ , while the cosmological bound is satisfied for  $\sin \xi \lesssim 10^{-5}$ . Such an alignment could follow from some GUT scale-universality in the soft terms [37] or from horizontal symmetries [38, 80].

Consider finally mechanism (iii). Trilinear  $R$ -parity violating couplings contribute to each entry of the neutrino mass matrix through lepton-slepton or quark-squark loops:

$$M_{ij}^\nu |_\lambda \simeq \sum_{k,l,m,n} \frac{\lambda_{ikl} \lambda_{jmn}}{8\pi^2} \frac{M_{kn}^e (\widetilde{M}_{LR}^{e2})_{ml}}{\widetilde{m}_e^2} \quad (53)$$

$$M_{ij}^\nu |_{\lambda'} \simeq \sum_{k,l,m,n} \frac{3 \lambda'_{ikl} \lambda'_{jmn}}{8\pi^2} \frac{M_{kn}^d (\widetilde{M}_{LR}^{d2})_{ml}}{\widetilde{m}_d^2} \quad (54)$$

where  $M^e$  ( $M^d$ ) is the charged lepton (down quark) mass matrix,  $\widetilde{M}_{LR}^{e2} = M_{ij}^e (A_{ij}^e + \mu \tan \beta)$  ( $\widetilde{M}_{LR}^{d2} = M_{ij}^d (A_{ij}^d + \mu \tan \beta)$ ) is the left-right slepton (down squark) mass-squared matrix,  $\widetilde{m}_e$  ( $\widetilde{m}_d$ ) is an averaged scalar mass, and 3 is a colour factor. Assuming no strong hierarchy among the  $A_{ij}^e$  and  $\lambda_{ijk}$  (the  $A_{ij}^d$  and  $\lambda'_{ijk}$ ) - or a flavour structure that is linked to the fermion mass hierarchy [78, 151] -, the contributions with  $k, l, m, n = 2$  or 3 dominate. To get an order of magnitude estimate, let us assume that the dominant diagrams involve tau-stau and bottom-sbottom loops, respectively, i.e.

$$M_{ij}^\nu |_\lambda \simeq \frac{\lambda_{i33} \lambda_{j33}}{8\pi^2} \frac{m_\tau^2 (A_\tau + \mu \tan \beta)}{m_\tau^2} \sim \lambda_{i33} \lambda_{j33} (4 \times 10^5 \text{ eV}) \left( \frac{100 \text{ GeV}}{\widetilde{M}_\tau} \right) \quad (55)$$

$$M_{ij}^\nu |_{\lambda'} \simeq \frac{3 \lambda'_{i33} \lambda'_{j33}}{8\pi^2} \frac{m_b^2 (A_b + \mu \tan \beta)}{m_b^2} \sim \lambda'_{i33} \lambda'_{j33} (8 \times 10^6 \text{ eV}) \left( \frac{100 \text{ GeV}}{\widetilde{M}_b} \right) \quad (56)$$

where  $\widetilde{M}_\tau$  ( $\widetilde{M}_b$ ) is a combination of  $\mu$ ,  $\tan \beta$  and soft parameters. Generic  $R$ -parity violating couplings would lead to a large electron neutrino mass; the present experimental bound on  $m_{\nu_e}$  therefore provides indirect limits on  $\lambda_{133}$  and  $\lambda'_{133}$ :

$$\lambda_{133} \lesssim 3.10^{-3} \left( \frac{\widetilde{M}_\tau}{100 \text{ GeV}} \right)^{\frac{1}{2}} \quad \text{and} \quad \lambda'_{133} \lesssim 7.10^{-4} \left( \frac{\widetilde{M}_b}{100 \text{ GeV}} \right)^{\frac{1}{2}} \quad (57)$$

Let us mention, however, that if the bottom-sbottom contribution (56) were dominant for each entry, the matrix  $M_{ij}^\nu$  would be singular at leading order since  $M_{ii}^\nu M_{jj}^\nu \simeq M_{ij}^\nu M_{ji}^\nu$ , resulting in a suppression of the light neutrino masses (as usual, the above limits are obtained by assuming that only one coupling is nonzero). In any case, a small  $R$ -parity violation, with  $\lambda$  and  $\lambda'$  couplings comparable in strength with Yukawa couplings, could induce neutrino masses in the phenomenologically interesting range, namely  $10^{-3} eV \lesssim m_\nu \lesssim 10 eV$ . This, of course, strongly depends on the model.

Let us stress, finally, that in any of the cases considered above, contributions (53) and (54) are present. Indeed, in both cases (i) and (ii), the lepton and down Higgs superfields have to be redefined in such a way that only  $H_d$  assumes a vev; it follows that trilinear  $R$ -parity violating couplings are generated even if they were absent from the initial theory.

We conclude that supersymmetry without  $R$ -parity implies neutrino masses and oscillations, and that a small  $R$ -parity violation could be of great relevance for neutrino phenomenology.

## 9 Conclusions and perspectives

The group of  $\mathcal{R}_p$  of the GDR for supersymmetry, after about two years of regular and successful running, has covered a wide range of activities in the fields of  $\mathcal{R}_p$  effects.

These activities have started with reviews of the state of the art and updates concerning indirect effects and bounds on  $R$ -parity odd interactions as well as reviews on the rich phenomenology and handful results obtained at the HERA and LEP colliders for which we have benefited of the work done in the collaborations i.e. H1, ALEPH, DELPHI, and L3, where members of the group of  $\mathcal{R}_p$  are active. The exploration of the phenomenology and discovery potential of  $\mathcal{R}_p$  effects has started in the LHC collaborations i.e. ATLAS and CMS, where members of the group of  $\mathcal{R}_p$  are also active. The study of the discovery potential mainly concerned at the moment the  $\lambda_{ijk}$  coupling. At the same time, simulation tools are developed in the group of  $\mathcal{R}_p$  in order to include  $\mathcal{R}_p$  effects in hadronic machines such as TEVATRON and LHC and these tools extend existing code like ISASUSY, SUSYGEN, SPYTHIA and EUROJET.

Theoretical contributions to the group of  $\mathcal{R}_p$  of the GDR for supersymmetry have covered fundamental aspects such as fermion mass models based on abelian family symmetries, leading to a hierarchy among  $\mathcal{R}_p$  couplings that mimics, in order of magnitude, the existing hierarchy among Yukawa couplings or models in which neutrino masses can be understood in terms of  $\mathcal{R}_p$  couplings effects. Theoretical activities also concerned important and more phenomenological aspects such as the production of single supersymmetric particles with the help of  $\mathcal{R}_p$  couplings at colliders like LEP and TEVATRON. In addition, we have benefited of the contributions from guests of the group of  $\mathcal{R}_p$  on various theoretical and phenomenological aspects of supersymmetry with  $\mathcal{R}_p$  (see [152]).

In the near future, we will continue to benefit from the work done at the HERA and LEP colliders for the search of  $\mathcal{R}_p$  effects and we will remain tuned for the update of new indirect effects on  $R$ -parity odd interactions. We hope to extend further the exploration of the phenomenology of  $\mathcal{R}_p$  effects at the LHC by considering  $\lambda'_{ijk}$  and  $\lambda''_{ijk}$  couplings. Future work can also include the study of  $\mathcal{R}_p$  effects at the next leptonic linear collider ( $\sqrt{s} \sim 500$  GeV or more). We will certainly have to face important questions concerning neutrino masses in terms of  $\mathcal{R}_p$  interactions and this will generate activities in the group of  $\mathcal{R}_p$ . Further theoretical developments on the fundamental side can include a better understanding of the possible hierarchy among  $\mathcal{R}_p$  couplings, this, along the lines described above or, why not, along new lines unfully explored yet, with the hope for explicit models to be derived and testable experimentally. On a more phenomenological side, the difficult task of developing tools for RGE including the  $\mathcal{R}_p$  couplings is still desirable but may wait for strong physical motivations. However, one cannot exclude that one of these motivations may come from the possibility that neutrino have mass that can be understood in terms of  $\mathcal{R}_p$  effects.

## 10 Appendix A

We adopt the summation convention over dummy indices. The conventions in the review of Haber and Kane are followed throughout [33]. We work in a metric of signature  $(+---)$  and use:  $P_{L,R} = (1 \mp \gamma_5)$ ,  $(g, g') = (g^2 + g'^2)^{\frac{1}{2}}(\cos \theta_W, \sin \theta_W)$ ,  $e/g = \sin \theta_W$ ,  $e/g' = \cos \theta_W$ ,  $m_W^2 = \frac{g^2 v^2}{4}$ ,  $m_Z^2 = \frac{(g^2 + g'^2)v^2}{4}$ ,  $(Z \ W) = \begin{pmatrix} \cos \theta_W & -\sin \theta_W \\ \sin \theta_W & \cos \theta_W \end{pmatrix} (W \ B)$ ,  $L = g' Y^\mu B_\mu + g J^{\mu a} W_\mu^a + g_3 J^{\mu \alpha} G_\mu^\alpha$ ,  $\tan \beta = v_u/v_d$ . Often, one uses the alternate notations:  $g' = g_1$ ,  $g = g_2$ ,  $g_3 = g_s$ . Frequent notations used in GUT or SGUT discussions are:  $g_a'^2 = g_a^2 k_a$ ,  $k_a = [1, 1, \frac{5}{3}]$ ,  $\frac{1}{k_a g_a^2} = \frac{1 - \beta_a t}{g_X^2}$ ,  $M_a(t) = m_{\frac{1}{2}}(1 - \beta_a t)$ ,  $\beta_a = b_a g_X^2 / (4\pi)^2$ ,  $t = \log m_X^2 / Q^2$ ,  $b_a = [3, -1, -11]$ ,  $[a = 3, 2, 1]$ . Numerical values for some familiar parameters are:  $m_P = \sqrt{8\pi}/\kappa = 1.22 \cdot 10^{19} GeV$ ,  $m_X = 2 \cdot 10^{16} GeV$ ,  $k_a g_a^2 = 4\kappa^2/\alpha' = 32\pi/(\alpha' M_P^2)$ ,  $M_{string} = g_X 5.27 \cdot 10^{17} GeV$ . The following notations for the Standard Model classical (tree level) parameters are also used:  $a(f_H) \equiv a_H(f) = a(\tilde{f}_H) = 2T_3^H(f) - 2Qx_W$ ,  $[H = L, R]$ ,  $x_W = \sin^2 \theta_W$ ;  $a(\tilde{f}_H^*) = -a(\tilde{f}_H)$ ,  $a_L(f^c) = -a_R(f)$ ,  $a_R(f^c) = -a_L(f)$ ,  $\frac{G_\mu}{\sqrt{2}} = \frac{g^2}{8M_W^2}$ . Recall that the input parameters employed in high precision tests of the standard model are chosen as the subset of best experimentally determined parameters among the basic set,  $[\alpha^{-1} = 137.036$ ,  $\alpha_s = 0.122 \pm 0.003$ ,  $m_Z = 91.186(2)$ ,  $G_\mu = 1.16639(1) \cdot 10^5 GeV^{-2}$ ,  $m_t(pole) = 175.6 \pm 5.0$ ,  $m_H]$ . The remaining parameters are then deduced by means of fits to the familiar basic data (Z-boson lineshape and decay widths,  $\tau$  polarization, forward-backward (FB) or polarization asymmetries, APV, beta decays, masses, ...). Experimental data can be consulted from the PDG compilation [34].

Useful auxiliary parameters for the  $\mathcal{R}_p$  coupling constants are,  $r_{ijk}(\tilde{e}_{kR}) = \frac{M_W^2}{g_2^2 \tilde{m}_{e_{kR}}^2} |\lambda_{ijk}|^2$ . In presenting numerical results for coupling constants, we distinguish between the first two families and the third by using middle and beginning alphabet indices, respectively, such that,  $l, m, n \in [1, 2]$  and  $i, j, k \in [1, 2, 3]$ . The following list of abbreviations is used:  $\mathcal{R}_p$  for  $R$ -parity violation, NC for neutral current, CC for charged current, BF for branching fraction, SM for Standard Model, and EDM for electric dipole moment. A factor  $d_{kR}^p$  in a numerical equation, such as,  $\lambda'_{11k} = n \times d_{kR}^p$ , stands for the notation,  $n \times (\frac{m_{d_{kR}}}{100 GeV})^p$ . The following notations for quadratic products of coupling constants are used:  $F_{abcd} = \sum_i \lambda_{iab} \lambda_{icd} (\frac{\tilde{m}_i}{100 GeV})^{-2}$ ,  $F'_{abcd} = \sum_i \lambda'_{iab} \lambda'_{icd} (\frac{\tilde{m}_i}{100 GeV})^{-2}$ .

## 11 Appendix B

The lagrangian in four-component Dirac notation describing the  $\mathcal{R}_p$  Yukawa interaction terms (i.e. couplings scalar-spinor-spinor) is [13, 144] :

$$\begin{aligned} \mathcal{L}_{\mathcal{R}_p} = & \lambda_{ijk} \left[ \tilde{\nu}_L^i \tilde{e}_R^k e_L^j + \tilde{e}_L^j \tilde{e}_R^k \nu_L^i + (\tilde{e}_R^k)^* (\tilde{\nu}_L^i)^c e_L^j - (i \leftrightarrow j) \right] + \\ & \lambda'_{ijk} \left[ \tilde{\nu}_L^i \tilde{d}_R^k d_L^j + \tilde{d}_L^j \tilde{d}_R^k \nu_L^i + (\tilde{d}_R^k)^* (\tilde{\nu}_L^i)^c d_L^j - \tilde{e}_L^j \tilde{d}_R^k u_L^j - \tilde{u}_L^j \tilde{d}_R^k e_L^j - (\tilde{d}_R^k)^* (\tilde{e}_L^j)^c u_L^j \right] + \\ & \lambda''_{ijk} \left[ (\tilde{u}_R^i)^c d_R^j \tilde{d}_R^k + (\tilde{u}_R^i)^c \tilde{d}_R^j d_R^k + \tilde{u}_R^i (\tilde{d}_R^j)^c d_R^k \right] \\ & + h.c. \end{aligned} \quad (58)$$

Here, the superscripts  $c$  stand for the charge conjugate spinors and the  $*$ , for the complex conjugate of scalar fields. The coupling constant  $\lambda$  is antisymmetric under the interchange of the first two indices while  $\lambda'$  is antisymmetric under the interchange of the last two. Therefore, there are 9+9 such couplings and 27  $\lambda'$  leading to 45 new coupling constants. The first two terms of equ.(58) induce a lepton number violation while the last one violates baryon number conservation.

# References

- [1] G. Farrar and P. Fayet, Phys. Lett. **B76**, 575 (1978)
- [2] S. Weinberg, Phys. Rev. **D26**, 287 (1982); N. Sakai and T. Yanagida, Nucl. Phys. **B197**, 533 (1982)
- [3] S. Weinberg, Phys. Rev. Lett. **48**, 1303 (1982); ibidem, **50**, 387 (1983)
- [4] C. Aulakh and R. Mohapatra, Phys. Lett. **B 119**, 136 (1983)
- [5] F. Zwirner, Phys. Lett. **B132**, 103 (1983)
- [6] L. Hall and M. Suzuki, Nucl. Phys. **B231**, 419 (1984)
- [7] I.H. Lee, Nucl. Phys. **B246**, 120 (1984)
- [8] J. Ellis, G. Gelmini, C. Jarlskog, G. G. Ross and J. W. F. Valle, Phys. Lett. **B150**, 142 (1985)
- [9] G. G. Ross and J. W. F. Valle, Phys. Lett. **B151**, 375 (1985)
- [10] S. Dawson, Nucl. Phys. **B261**, 297 (1985)
- [11] R. Barbieri and A. Masiero, Nucl. Phys. **B267**, 679 (1986)
- [12] S. Dimopoulos and L. J. Hall, Phys. Lett. **B207**, 210 (1987)
- [13] V. Barger, G.F. Giudice and T. Han, Phys. Rev. **D40**, 2987 (1989)
- [14] H. Dreiner and G. G. Ross, Nucl. Phys. **B365**, 597 (1991)
- [15] R. Mohapatra, Prog. Part. Nucl. Phys. **31**, 39 (1993)
- [16] G. Bhattacharyya, Susy '96, Nucl. Phys. B (Proc. Suppl.) **52A**, 83 (1997); see also hep-ph/9709395
- [17] H. Dreiner, hep-ph/9707435
- [18] L. Ibanez and G. G. Ross, Phys. Lett. **B260**, 291 (1991); Nucl. Phys. **B368**, 3 (1992)
- [19] I. Hinchliffe and T. Kaeding, Phys. Rev. **D47**, 279 (1993)
- [20] K. Agashe and M. Graesser, Phys. Rev. **D54**, 4445 (1996)
- [21] S. Davidson and J. Ellis, Phys. Rev. **D56**, 4182 (1997)
- [22] J. Ellis, S. Lola and G. G. Ross, CERN-TH/97-205, hep-ph/9803308
- [23] D. Choudhury and P. Roy, Phys. Lett. **B378**, 153 (1996)
- [24] J.-H. Jang, J. K. Kim and J. S. Lee, Phys. Rev. **D55**, 7296 (1997)
- [25] J. E. Kim, P. Ko and D.-G. Lee, Phys. Rev. **D56**, 100 (1997)
- [26] R. M. Godbole, R. P. Roy and X. Tata, Nucl. Phys. **B401**, 67 (1993)
- [27] M. Hirsch, H. V. Klapdor-Kleingrothaus and S. G. Kovalenko, Phys. Rev. Lett. **75**, 17 (1995); ibidem, Phys. Rev. **D53**, 1329 (1996); ibidem, Susy '96 Nucl. Phys. B (Proc. Suppl.) **52A**, 257 (1997)
- [28] K. S. Babu and R. N. Mohapatra, Phys. Rev. Lett. **75**, 2276 (1995)
- [29] M. Hirsch and H. V. Klapdor-Kleingrothaus, Susy '97 Nucl. Phys. B (Proc. Suppl.) **62B**, 224 (1998)
- [30] A. Yu. Smirnov and F. Vissani, Phys. Lett. **B380**, 317 (1996)
- [31] C. E. Carlson, P. Roy and M. Sher, Phys. Lett. **B357**, 99 (1995)
- [32] J. L. Goity and M. Sher, Phys. Lett. **B346**, 69 (1995)
- [33] H.E. Haber and G.L. Kane, Phys. Rep. **117**, 175 (1985)
- [34] Particle Data Group, Phys. Rev. **D54**, 1 (1996)
- [35] A. Masiero and J. W. F. Valle, Phys. Lett. **B251**, 273 (1990); J. W. F. Valle, Physics from Planck scale to electroweak scale, Proc. US-Polish Workshop, (21-24 Sept. 1994, Warsaw); C. A. Santos and J. W. F. Valle, Phys. Lett. **B288**, 311 (1992); M. C. Gonzalez-Garcia, J. C. Romão and J. W. F. Valle, Nucl. Phys. **B 391**, 100 (1993)



- [36] R. Barbieri, D. E. Brahm, L. J. Hall, S. D. H. Hsu, Phys. Lett. **B238**, 86 (1990)
- [37] H. P. Nilles and N. Polonsky, Nucl. Phys. **B484**, 33 (1997), hep-ph/9606388
- [38] T. Banks, Y. Grossman, E. Nardi and Y. Nir, Phys. Rev. **D52**, 5319 (1995); E. Nardi, Phys. Rev. **D55**, 5772 (1997)
- [39] Y. Grossman and H. Haber, Phys. Rev. Lett. **78**, 3438 (1997); M. Hirsch, H. V. Klapdor-Kleingrothaus and S. G. Kovalenko, Phys. Lett. **B398**, 311 (1997)
- [40] E. Eichten, K. Lane and M. Peskin, Phys. Rev. Lett. **50**, 811 (1983)
- [41] ALEPH Collaboration; DELPHI Collaboration; OPAL Collaboration, LP'97 (Hamburg, 1997)
- [42] F. Abe et al., CDF Collaboration, Phys. Rev. Lett. **77**, 5336 (1996)
- [43] G. Altarelli, Susy '97 Nucl. Phys. B (Proc. Suppl.) **62B**, 3 (1998)
- [44] V. Barger, K. Cheung, K. Hagiwara and D. Zeppenfeld, Phys. Rev. **D57**, 357 (1998), hep-ph/9707412
- [45] G. Altarelli, G. F. Giudice and M. L. Mangano, Nucl. Phys. **B506**, 29 (1997), hep-ph/9705287
- [46] J. Erler, J. Feng and N. Polonsky, Phys. Rev. Lett. **78**, 3012 (1997)
- [47] P. Langacker, Introduction in "Precision tests of Standard Model of electroweak interactions", ed. P. Langacker (World Scientific, Singapore, 1996)
- [48] F. Ledroit and G. Sajot, Rapport GDR-Supersymétrie, GDR-S-008 (ISN, Grenoble, 1998)  
[http://qcd.th.u-psud.fr/GDR\\_SUSY/GDR\\_SUSY\\_PUBLIC/GDR-S-008.ps](http://qcd.th.u-psud.fr/GDR_SUSY/GDR_SUSY_PUBLIC/GDR-S-008.ps)
- [49] G. Bhattacharyya and D. Choudhury, Mod. Phys. Lett. **A10**, 1699 (1995)
- [50] Y. Grossman, Z. Ligeti and E. Nardi, Nucl. Phys. **B465**, 369 (1996)
- [51] C. S. Wood et al, Science, **275**, 1759 (1997)
- [52] J. Ellis, G. Bhattacharyya, and K. Sridhar, Mod. Phys. Letters, **A10**, 1583 (1995)
- [53] C. H. Chen, C. Q. Geng and C. C. Lih, Phys. Rev. **D56**, 6856 (1997)
- [54] B. de Carlos and P. L. White, Phys. Rev. **D54**, (1996) 3427
- [55] M. Frank and H. Hamidian, hep-ph/9706510
- [56] W. Marciano, Susy '97 Nucl. Phys. B (Proc. Suppl.) **62B**, 457 (1998)
- [57] M. Günther et al., Phys. Rev. **D55**, 54 (1996)
- [58] I. I. Bigi and F. Gabbiani, Nucl. Phys. **B367**, 3 (1991)
- [59] A. Wodecki and W. A. Kaminski, hep-ph/9806288
- [60] D. E. Kaplan, hep-ph/9703347
- [61] P. Langacker, Phys. Reports, **72**, 185 (1981)
- [62] A. Masiero, Int. School for Advanced studies, Grand unification with and without supersymmetry and cosmological implications (World Scientific, Singapore, 1984)
- [63] A. Bouquet and P. Salati, Nucl. Phys. **B284**, 557 (1987)
- [64] E. W. Kolb and M. S. Turner, The Early Universe (Addison-Wesley Publishing Company, 1990)
- [65] B. S. Campbell, S. Davidson J. Ellis and K. Olive, Phys. Lett. **B 256**, 457 (1991)
- [66] W. Fischler, G. Giudice, R. S. Leigh and S. Paban, Phys. Lett. **B258**, 45 (1991)
- [67] H. Dreiner and G. G. Ross, Nucl. Phys. **B410**, 188 (1993)
- [68] H. Murayama and D. B. Kaplan, Phys. Lett. **B336**, 221 (1994)
- [69] R. Arnowitt and P. Nath, Phys. Rev. **D 38**, 1479 (1988)
- [70] J. Ellis, D. V. Nanopoulos, S. Rudaz, Nucl. Phys. **B202**, 43 (1982)

- [71] J. Hisano, H. Murayama and T. Yanagida, Nucl. Phys. **B402**, 46 (1993)
- [72] B. Brahmarchi and P. Roy, Phys. Rev. **D50**, R39 (1994)
- [73] V. Barger, M. S. Berger, W.-Y. Keung, R. J. N. Phillips and T. Wöhrmann, Nucl. Phys. B (Proc. Suppl.) **52B**, 69 (1997);
- [74] V. Barger, M. S. Berger, R. J. N. Phillips and T. Wöhrmann, Phys. Rev. **D53**, 6407 (1996)
- [75] A. Cohen, D. B. Kaplan and A. Nelson Phys. Lett. **B388**, 588 (1996)
- [76] R. Barbieri, A. Strumia and Z. Berezhiani, Phys. Lett. **B407** (1997) 250.
- [77] V. Ben-Hamo and Y. Nir, Phys. Lett. **B339** (1994) 77.
- [78] T. Banks, Y. Grossman, E. Nardi and Y. Nir, Phys. Rev. **D52** (1995) 5319.
- [79] P. Binétruy, S. Lavignac and P. Ramond, Nucl. Phys. **B477** (1996) 353.
- [80] F. Borzumati, Y. Grossman, E. Nardi and Y. Nir, Phys. Lett. **B384** (1996) 123.
- [81] P. Binétruy, E. Dudas, S. Lavignac and C. Savoy, Phys. Lett. **B422** (1998) 171.
- [82] J. Ellis, S. Lola and G.G. Ross, preprint hep-ph/9803308.
- [83] C.D. Froggatt and H.B. Nielsen, Nucl. Phys. **B147** (1979) 277; L.E.Ibanez and G.G. Ross, Phys. Lett. **B332** (1994) 100; P. Binétruy and P. Ramond, Phys. Lett. **B350** (1995) 49; E. Dudas, S. Pokorski and C. Savoy, Phys. Lett. **B356** (1995) 43; P. Binétruy, S. Lavignac and P. Ramond, Nucl. Phys. **B477** (1996) 353.
- [84] R. Hempfling, Nucl. Phys. **B478** (1996) 3.
- [85] G. Giudice and A. Masiero, Phys. Lett. **B206** (1988) 480.
- [86] D. Choudhury, Phys. Lett. **B376** (1996) 201
- [87] D. K. Ghosh, S. Raychaudhuri and K. Sridhar, hep-ph/9608352
- [88] M. Chemtob and G. Moreau, "Broken  $R$ -parity contributions to flavor changing rates and CP asymmetries in fermion pair production at leptonic colliders", hep-ph/9806494.
- [89] S. Dimopoulos, R. Esmailzadeh, L.J. Hall, J. Merlo and G.D. Starkman, Phys. Rev. **D41** (1990) 2099
- [90] J. L. Hewett, Proceedings, "1990 Summer Study on High Energy Physics", Snowmass, Colorado; T.Kon and T. Kobayashi, Phys. Lett. **B270** (1991) 81; H. Dreiner and P. Morawitz, Nucl. Phys. **B428** (1994) 31; D. Choudhury and S. Raychaudhuri, hep-ph/9702392; G. Altarelli, J. Ellis, G. F. Giudice, S. Lola and M.L.Mangano, hep-ph/9703276; H. Dreiner and P. Morawitz, hep-ph/9703279; J. Kalinowski, R. Ruckl, H. Spiesberger and P.M. Zerwas, hep-ph/9703288; K. S. Babu, C. Kolda, J. M. Russell and F. Wilczek, hep-ph/9703299; E. Perez, Y. Sirois and H. Dreiner, hep-ph/9703444; T.Kon and T. Kobayashi, hep-ph/9704221; J. Ellis, S. Lola and K. Sridhar, Phys. Lett. **B408** (1997) 252; J. E. Kim and P. Ko, hep-ph/9706387; U. Mahanta and A. Ghosal, hep-ph/9706398; S. Lola, hep-ph/9706519; M. Guchait and D. P. Roy, hep-ph/9707275; T. Kon, T. Matsushita and T. Kobayashi, hep-ph/9707355; M. Carena, D. Choudhury, S. Raychaudhuri and C. E. M. Wagner, hep-ph/9707458.
- [91] C. Adloff and al, H1 Coll., DESY 97-024 and Z. Phys. **C74** (1997) 191; J. Breitweg and al, Zeus Coll., DESY 97-025 and Z. Phys. **C74** (1997) 207.
- [92] A. Datta, J. M. Yang, B. Young and X. Zhang, hep-ph/9704257
- [93] R. J. Oakes, K. Whisnant, J. M. Yang, B. Young and X. Zhang, hep-ph/9707477
- [94] J. Erler, J.L. Feng and N. Polonsky, Phys. Rev. Lett. **78** (1997) 3063
- [95] J. Kalinowski, R. Ruckl, H. Spiesberger and P.M. Zerwas, Phys. Lett. **B406** (1997) 314
- [96] J. Kalinowski, R. Ruckl, H. Spiesberger and P.M. Zerwas, Phys. Lett. **B414** (1997) 297
- [97] DELPHI Coll., DELPHI 97-119 CONF 101, 20 July, 1997
- [98] B.C. Allanach, H. Dreiner, P. Morawitz and M.D. Williams, hep-ph/9708495

- [99] H.Dreiner and S. Lola, published in "Munich /Annecy/Hamburg 1991 , Proceedings,  $e^+e^-$  collisions at 500 GeV"; "Searches for New Physics", contribution to the LEP II workshop, 1996, hep-ph/9602207; "Physics with  $e^+e^-$  Linear Colliders", DESY-97-100, hep-ph/9705442.
- [100] M. Chemtob and G. Moreau, "Systematics of single production at leptonic supercolliders", to appear
- [101] H1 Collaboration, C. Adloff et al., Z. Phys. **C74** (1997) 191.
- [102] ZEUS Collaboration, J. Breitweg et al., Z. Phys. **C74** (1997) 207.
- [103] M. Drees, Phys. Lett. **B403** (1997) 353;
- [104] U. Bassler and G. Bernardi, Z. Phys. **C76** (1997) 223-230.
- [105] T.K. Kuo and T. Lee, Mod. Phys. Lett. **A12** (1997) 2367; K.S. Babu et al., Phys. Lett. **B402** (1997) 367; J.L. Hewett and T.G. Rizzo, Phys. Lett. **B403** (1997) 353; Z. Kunszt and W.J. Stirling, Z. Phys. **C75** (1997) 453; T. Plehn et al., Z. Phys. **C74** (1997) 611; C. Friberg, E. Norrbin and T. Sjöstrand, Phys. Lett. **B403** (1997) 329; J.K. Elwood and A.E. Faraggi, Nucl. Phys. **B512** (1998) 42; M. Heyssler and W.J. Stirling, Phys. Lett. **B407** (1997) 259; J. Blümlein, Proceed. of the 5th Int. Workshop on Deep Inelastic Scattering and QCD (DIS 97), Chicago, USA (14-18 April 1997) 5pp.; E. Keith and E. Ma, Phys. Rev. Lett. **79-22** (1997) 4318; N.G. Deshpande and B. Dutta, Phys. Lett. **B424** (1998) 313; J.L. Hewett and T.G. Rizzo, SLAC preprint PUB-7549 (August 1997) 45pp.; T.G. Rizzo, Proceed. of the Workshop on Physics Beyond the Desert 1997, Tegernsee, Germany (8-14 June 1997) 32pp.; Z. Xiao, RAL preprint TR-97-043 (September 1997) 26pp.; R. Ruckl and H. Spiesberger, Proceed. of the Workshop on Physics Beyond the Desert, Tegernsee, Germany (8-14 Jun 1997) 18pp.; M. Sekiguchi, H. Wada and S. Ishida, Nihon Univ. preprint NUP-A-97-23 (December 1997) 7 pp.
- [106] D. Choudhury and S. Raychaudhuri, Phys. Lett. **B401** (1997) 54; G. Altarelli et al., Nucl. Phys. **B506** (1997) 3; H. Dreiner and P. Morawitz, Nucl. Phys. **B503** (1997) 55; T. Kon and T. Kobayashi, Phys. Lett. **B409** (1997) 265; G. Altarelli, G.F. Giudice and M.L. Mangano, Nucl. Phys. **B506** (1997) 29; J. Ellis, S. Lola, K. Sridhar, Phys. Lett. **B408** (1997) 252; J.E. Kim and P. Ko, Phys. Rev. **D57** (1998) 489; S. Lola, Proceed. of the 5th Int. Workshop on Deep Inelastic Scattering and QCD, Chicago, USA, (April 14-18, 1997) 5pp.; T. Kon, T. Matsushita and T. Kobayashi, Mod. Phys. Lett. **A12** (1997) 3143; M. Carena et al., Phys. Lett. **B414** (1997) 92-103; G. Altarelli, Proceedings of the SUSY 1997 Conference, Nucl. Phys. Proc. Suppl. **62** (1998) 3; R. Rueckl, H. Spiesberger, Proceed. of the Workshop New Trends in HERA Physics, Tegernsee, Germany (May 25-30,1997) 14pp.; A. S. Joshipura, V. Ravindran and S. K. Vempati, Physics Review **D57** (1998) 5327; J. Ellis, Proceed. of the Europhysics Conf. on High-Energy Physics, Jerusalem (August 1997) 8pp. S. Raychaudhuri, Proceed. of the International Workshop on Physics Beyond the Standard Model, Valencia, Spain (October 13 - 17, 1997) 5pp.; E. Asakawa, J. Kamoshita and A. Sugamoto, Ochanumizu Univ. preprint PP-115 (March 1998) 15pp.. A.S. Joshipura, Proceed. of the Int. Workshop on Physics Beyond the Standard Model, Valencia, Spain, (13-17 October 1997) 6pp.
- [107] A. Masiero and A. Riotto, Phys. Lett. **B289** (1992) 73; U. Sarkar and R. Adhikari, Phys. Rev. **D55** (1997) 3836.
- [108] H1 Collaboration, S. Aid et al., Phys. Lett. **B380** (1996) 461; V. Noyes for the ZEUS Collaboration, Proceed. of the Hadron Collider Physics Conf. HCP97, Stony Brook (June 1997) 19pp.
- [109] H1 Collaboration, T. Ahmed et al., Z. Phys. **C64** (1994) 545.
- [110] J. Butterworth and H. Dreiner, Nucl. Phys. **B397** (1993) 3, and references therein.
- [111] H1 Collaboration, S. Aid et al., Phys. Lett. **B369** (1996) 173.
- [112] W. Buchmüller, R. Rückl and D. Wyler, Phys. Lett. **B191** (1987) 442.
- [113] H1 Collaboration, S. Aid et al., Z. Phys. **C71** (1996) 211.
- [114] E. Perez, "Recherche de Particules en Supersymétrie Violant la R-parité dans H1 à HERA", Thèse de Doctorat, DAPNIA/SPP report 96-1006 (in French).
- [115] E. Perez and Y. Sirois, Proceed. of the Int. Workshop on Dark Matter in Astro- and Particle Physics, Heidelberg, Germany (16-20 September 1996) p. 615.
- [116] J.F. Gunion and H.E. Haber, Nucl. Phys. **B272** (1986) 1.
- [117] T. Kon, T. Kobayashi and S. Kitamura, Phys. Lett. **B333** (1994) 263; T. Kon et al., Z. Phys. **C61** (1994) 239.
- [118] H1 Collaboration, T. Ahmed et al., Z. Phys. **C64** (1994) 545;
- [119] H1 Collaboration, Contributed paper no. 580 to the XXIX Int. Conf. on High Energy Physics, Vancouver, Canada (23-29 July 1998).
- [120] ZEUS Collaboration, Z.Phys. **C73** (1997) 613
- [121] S. Davidson, D. Bailey and B. Campbell, Z. Phys. **C61** (1994) 613.

- [122] CDF Collaboration, F. Abe et al., Phys. Rev. Lett. **79** (1997) 4327; D0 Collaboration, B. Abbot et al., Phys. Rev. Lett. **79** (1997) 4321; *ibid*, Phys. Rev. Lett. **80** (1998) 2051.
- [123] ALEPH collaboration, Phys. Lett. **B349** (1995) 238;  
OPAL collaboration, Phys. Lett. **B313** (1993) 333;
- [124] ALEPH collaboration, Phys. Lett. **B384** (1996) 461.
- [125] ALEPH collaboration, Searches for  $R$ -parity violating supersymmetry at LEP II, submitted to the 1997 EPS-HEP conference Jerusalem ref. EPS-621 Pa. 13, Pl 9,17;  
ALEPH collaboration, Search for  $R$ -parity violating Supersymmetry in  $e^+e^-$  Collisions at centre-of-mass energies of 181-184 GeV, ALEPH 98-027 Conf 98-015;  
DELPHI collaboration, Search for  $R$ -parity violating effects at  $\sqrt{s}$  161 and 172 GeV, submitted to the 1997 EPS-HEP conference Jerusalem, Delphi 97-119, conf 101, Pa. 11,13, Pl 9,15,17;  
OPAL collaboration, Search for  $R$ -parity Violating decays of Supersymmetric particles at LEP2, submitted to the 1997 EPS-HEP conference Jerusalem, Pa. 11,13, Pl 9,15,17;  
L3 collaboration, Search for Supersymmetric particles violating  $R$ -parity with the L3 detector at LEP, submitted to the 1997 EPS-HEP conference Jerusalem, Pa. 11,13, Pl 9,15,17.
- [126] This report - MSSM group
- [127] This report - LSP group
- [128] P. Abreu et al., Nucl. Instr. Meth. **378** (1996) 57
- [129] S. Katsanevas, P. Morawitz,  
<http://lyohp5.in2p3.fr/delphi/katsan/susygen.html>
- [130] Physics at LEP2, CERN Yellow Report 96-01, vol.1, p.207
- [131] See for example :  
H. Baer et al., Phys. Rev. **D52** (1995) 2746  
H. Baer et al., Phys. Rev. **D53** (1996) 6241
- [132] ATLAS-PHYS-No-107
- [133] ATLAS-PHYS-No-108
- [134] ATLAS-PHYS-No-109
- [135] ATLAS-PHYS-No-110
- [136] ATLAS-PHYS-No-111
- [137] see e.g. dans Physics at LEP2 vol 2. page 328
- [138] A.Mirea: The program RPV\_ISAJET, an extension of ISAJET for the case of  $R$ -parity violation (writeup in preparation)
- [139] ATLAS-PHYS-No-079
- [140] A.Mirea and E.Nagy: Study of the sensitivity of the ATLAS detector in testing the SUGRA model in case of  $R$ -parity violation (to appear in the ATLAS Physics Technical Design Report)
- [141] A.Mirea: Etude de la violation de la R parité auprès du LHC (thesis in preparation)
- [142] T. Sjöstrand, Comput. Commun. **82** (1994) 74
- [143] S. Mrenna, Comput. Commun. **101** (1997) 232
- [144] E.A. Baltz and P. Gondolo, Phys. Rev. **D57** (1998) 2969
- [145] S. Abdullin et al., CMS TN/94-180
- [146] P. Paganini et al., CMS Technical Note and GDR-SUSY note in preparation.
- [147] M. Gell-Mann, P. Ramond, and R. Slansky in Sanibel Talk, CALT-68-709, Feb 1979, and in *Supergravity* (North Holland, Amsterdam 1979). T. Yanagida, in *Proceedings of the Workshop on Unified Theory and Baryon Number of the Universe*, KEK, Japan, 1979.

- [148] J. Ellis et al., Phys. Lett. **B150** (1985) 142; D.E. Brahm, L.J. Hall and S. Hsu, Phys. Rev. **D42** (1990) 1860.
- [149] K.S. Babu and R.N. Mohapatra, Phys. Rev. Lett. **64** (1990) 1705; R. Barbieri *et al.*, Phys. Lett. **B252** (1990) 251; E. Roulet and D. Tommasini, Phys. Lett. **B256** (1991) 218; K. Enqvist, A. Masiero and A. Riotto, Nucl. Phys. **B373** (1992) 95;
- [150] H. Georgi, S.L. Glashow and S. Nussinov, Nucl. Phys. **B193** (1981) 297; M. Fukugita, S. Watamura and M. Yoshimura, Phys. Rev. Lett. **48** (1982) 1522.
- [151] E. Dudas and S. Lavignac, note GDR-S-010.
- [152] See talks of:  
S.Lola, Strange-stop interpretation of the HERA data and implications for  $R$ -parity violation at LEP2;  
C.Wagner,  $R$ -parity violation , theoretical review;  
S.Davidson, Cosmological implications of broken  $R$ -parity  
S.Abel, Metastability and  $R$ -parity.  
Most of the transparencies are available at:  
<http://cdfinfo.in2p3.fr/Store/Gdrsusy/reunion.html>