



HAL
open science

Status of Virgo

F. Acernese, P. Amico, M. Alshourbagy, F. Antonucci, S. Aoudia, P. Astone,
S. Avino, D. Babusci, G. Ballardín, F. Barone, et al.

► **To cite this version:**

F. Acernese, P. Amico, M. Alshourbagy, F. Antonucci, S. Aoudia, et al.. Status of Virgo. 42nd Rencontres de Moriond: Gravitational Waves and Experimental Gravity, Mar 2007, La Thuile, Italy. in2p3-00190873

HAL Id: in2p3-00190873

<https://hal.in2p3.fr/in2p3-00190873>

Submitted on 23 Nov 2007

HAL is a multi-disciplinary open access archive for the deposit and dissemination of scientific research documents, whether they are published or not. The documents may come from teaching and research institutions in France or abroad, or from public or private research centers.

L'archive ouverte pluridisciplinaire **HAL**, est destinée au dépôt et à la diffusion de documents scientifiques de niveau recherche, publiés ou non, émanant des établissements d'enseignement et de recherche français ou étrangers, des laboratoires publics ou privés.

Status of Virgo

VIRGO AUTHOR LIST (please be sure that M. Evans is included!)
*MIT Kavli Institute for Astrophysics and Space Research, Building 37, 70 Vassar Street,
Cambridge MA 02139, USA*

The commissioning phase of the full Virgo gravity-wave interferometric detector started in September 2003, and ended in May 2007 as the data taking phase began. This activity was intended to achieve a stable operation of the detector, at its design strain sensitivity, in the frequency bandwidth extending from about 10 Hz up to a few kHz, with a value of a few 10^{-23} around 500 Hz. In September 2006 the first weekend science run (WSR 1) was held, followed by one or two more each month until WSR 10 in March 2007. The WSRs served to test the detector performance and reliability, and to prepare the transition to the long scientific data taking period which started on 18 May 2007. In this article the main features of Virgo, together with its actual status and sensitivity at the beginning of its first long science run, are presented.

1 Introduction

Gravitational waves are perturbations of the space-time metric that are generated by any mass having a time-varying quadrupole moment¹. Like electromagnetic waves, gravitational waves are transverse, propagate at the speed of light, and have two polarization states. Their effect on a set of free falling bodies is to modify their relative distances in a direction perpendicular to the wave vector. Unlike electromagnetic waves, gravitational waves have a quadrupolar nature; if the distance between two free falling masses decreases along the north-south direction then it increases along the east-west direction, and the opposite will happen half a period later.

Due to the very small value of the gravitational coupling constant, the generation of gravitational waves requires a rapidly varying quadrupole moment of compact, massive and relativistic objects. For this reason, gravitational waves of detectable amplitudes are expected to be produced by compact astrophysical sources such as the coalescence of binaries formed by black holes and neutron stars, the collapses of stellar cores, or the rotation of non axis-symmetric neutron stars². The detection of gravitational waves emitted by these gravitationally violent astrophysical events will provide new information about the range of validity of general relativity, and nuclear physics in extreme gravitational fields. In addition to these sources, a background of gravitational waves is expected to have been formed immediately after the big-bang (much like the well known cosmic microwave background). The detection of such a background could provide unique information about the processes taking place during the Planck era.

For more than forty years the search for gravitational waves has been pursued with resonant detectors made of metallic bars a few meters in length⁴. The development of gravitational wave detectors based on laser interferometers started in the early seventies⁵. After more than two decades of development, the construction of the first interferometers with kilometer scale arms started in the nineties. This new generation of detectors^{6,7,8} is now entering the operation phase.

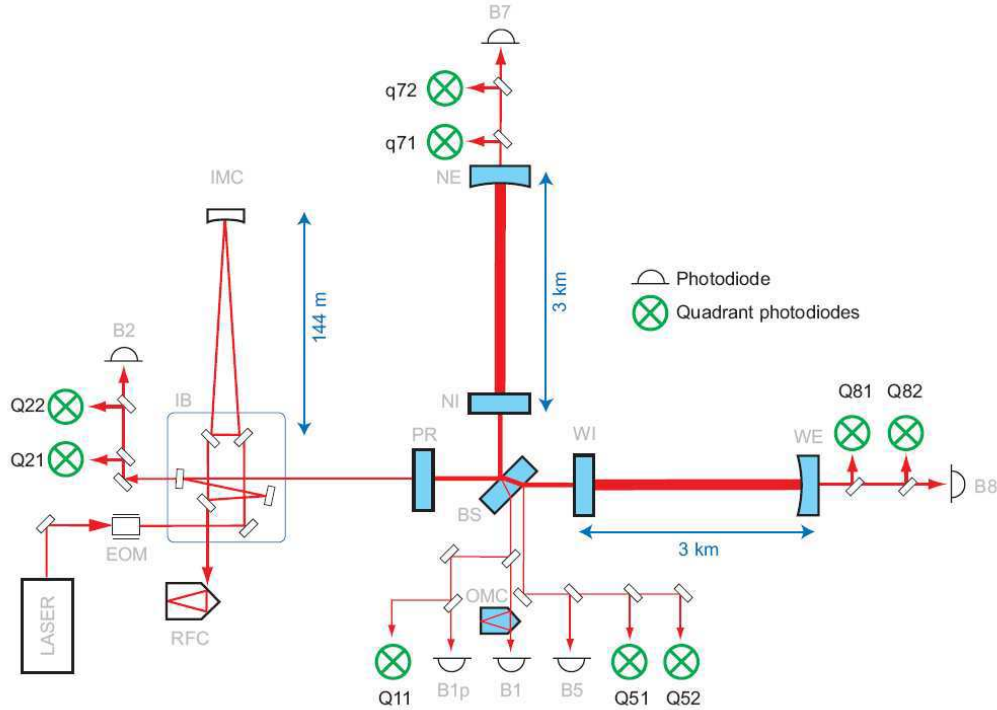

Figure 1: The optical lay-out of the Virgo interferometer.

The sensitivity of a gravitational wave detector is fundamentally proportional to its length, and with its 3 kilometer long arms Virgo⁷ is the largest gravitational wave detector in Europe, and the third largest in the world.

2 The design of the Virgo detector

The Virgo detector is based on a laser interferometer with 3 km long arms. The main features of the detector are shown in Figure 1. Each arm includes a Fabry-Perot cavity with a finesse of 50 in order to amplify the phase shift produced by a variation of the arm length⁹. Since one of the limitations to the detector sensitivity results from the fluctuations of the number of photons detected at the interferometer output port (shot noise), the sensitivity can be improved by increasing the number of photons injected into the arms thus reducing their relative fluctuation⁵. To this purpose the interferometer output port is tuned to the minimum of transmission so that all the light is reflected toward the laser port. By properly placing an additional mirror, called the power recycling mirror⁹, between the laser and the interferometer, this light is re-injected into the interferometer thus increasing the power impinging on the beam-splitter by about a factor 40.

The value of the recycling factor depends on the amount of light lost inside the interferometer which itself depends on the quality of the mirror surfaces (flatness and microroughness) and on the absorption in the substrates and in the coatings. Keeping these parameters as small as possible becomes more and more difficult as the size of the mirror is increased. The Virgo mirrors are 35 cm in diameter and 10 cm thick, for a total weight of about 20 kg. The final figure obtained for the mirrors (measured before installation) amounted to 3-4 nm rms for the flatness defects and less than 0.05 nm for the microroughness¹⁰.

A more direct way to increase the number of photons injected into the interferometer is

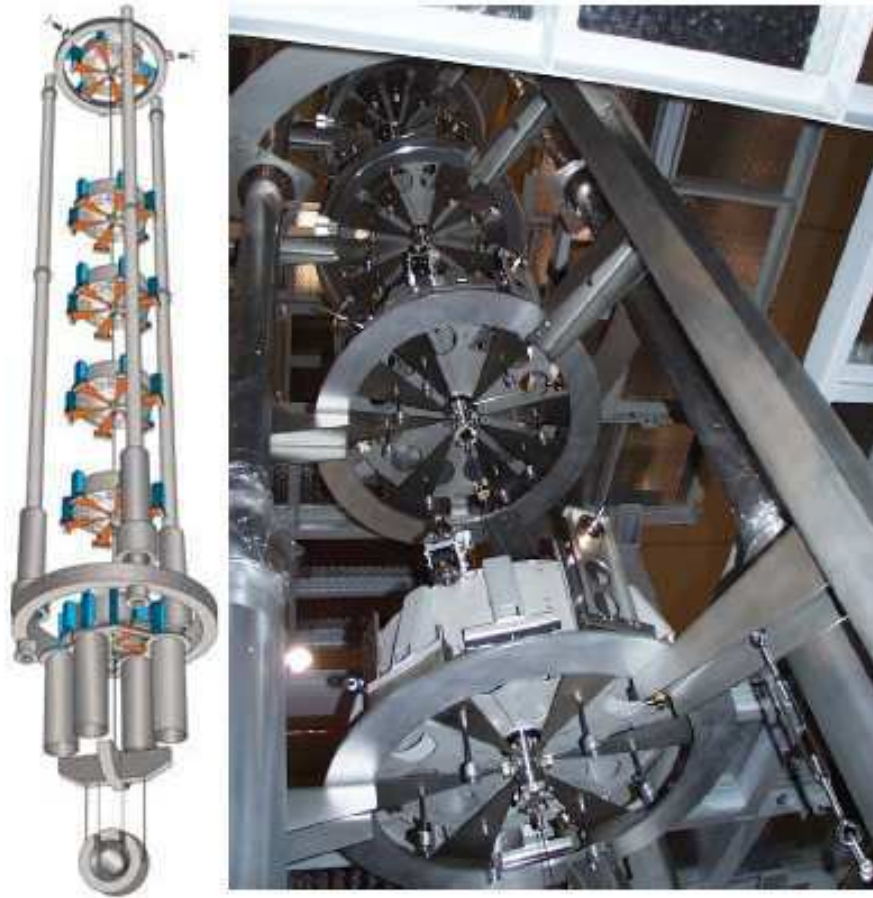

Figure 2: Isolation from seismic motion is provided to the Virgo core optics by a series of mechanical filters.

to increase the laser power. In practice this possibility is limited by the laser beam quality (geometry and stability) that usually degrades as the power is increased. Moreover a larger power requires that all the associated optics be able to support the corresponding larger thermal load. The solution adopted by Virgo is a 20 Watt Nd:YVO4 laser, injection locked to a 1 Watt Nd:YAG master laser. Of the 20 Watts available, about 8 Watts currently arrive at the power recycling mirror for use in the interferometer.

Before the laser beam is injected into the interferometer it is filtered through a triangular suspended cavity, called input mode-cleaner¹¹. This cavity has a finesse of 1000, a length of 144 m and its main purpose is to improve the spatial quality of the beam and reduce beam jitter. The same cavity is also used for the laser frequency pre-stabilization. This cavity as well as all the rest of the interferometer is kept under vacuum to eliminate the effect of acoustic noise and of the fluctuations in refraction index.

A shorter mode-cleaner (3.6 cm long) is used at the interferometer output port to filter out the spurious diffused light produced by the mirror defects¹². This small cavity is located on a suspended optical bench and is under vacuum. The beam transmitted by the output mode-cleaner is then detected by InGaAs photodiodes¹³ placed outside the vacuum chamber.

All the main interferometer mirrors are suspended from seismic isolators based on six-stages pendulums (shown in Figure 2). Each stage of the pendulum is a seismic filter based on cantilever springs that provide the required vertical isolation^{14,16}. The six-stage pendulum is itself suspended to an inverted pendulum that provides attenuation of horizontal seismic motion starting around 40 mHz (depending on the exact tuning)¹⁵. The total height of the seismic isolator

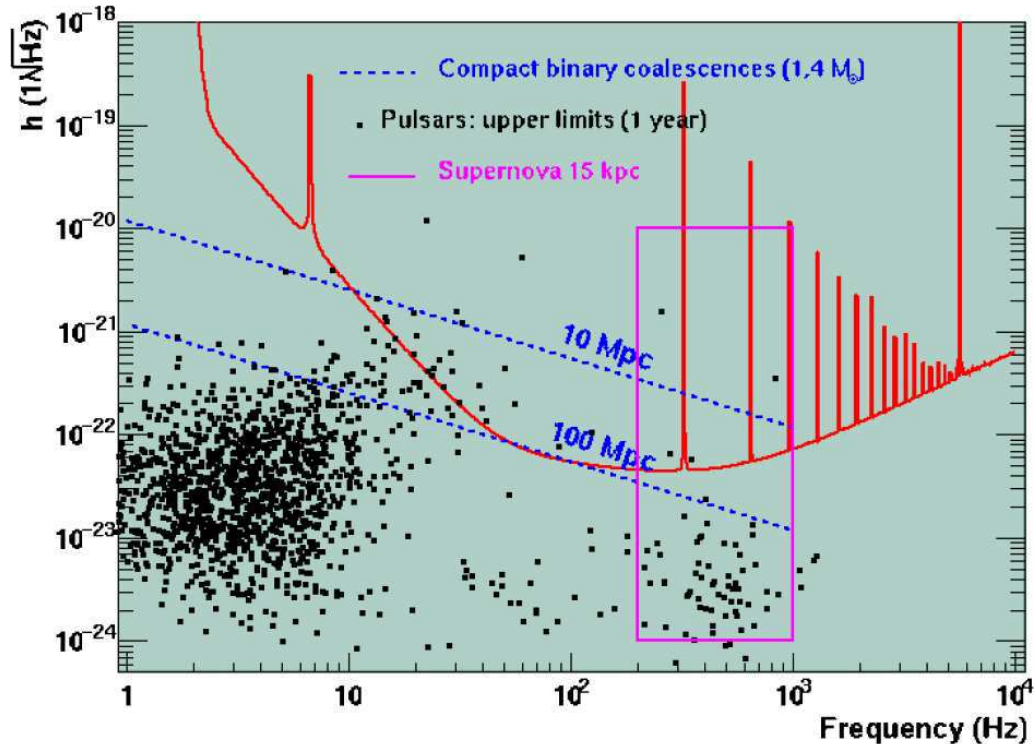

Figure 3: The Virgo design sensitivity as a function of the frequency. For comparison the amplitude of some of the expected sources are superposed on the same plot.

is about 10 m. Attached to the top of the inverted pendulum are three accelerometers¹⁷. The signals of these inertial sensors properly combined with the signals provided by three position sensors¹⁸ are used to damp the residual motion of the seismic isolator below a few Hz¹⁹.

Each mirror is suspended by means of four thin steel wires to an intermediate mass (called marionette) that is itself suspended to the last stage of the seismic isolator²⁰. Also suspended to the marionette is an additional mass, called reference mass, which encompasses the mirror so that its center of mass coincides with that of the mirror. Four coils attached to the reference mass and four small magnets glued to the mirror back face permit to adjust the mirror longitudinal and angular positions. Larger displacements can be obtained by flowing currents through four coils attached to the last stage of the seismic isolator and acting on four magnets attached to the marionette. This ensemble of actuators are used to properly align the mirrors and to control the mirror position in order to keep the interferometer at the required working point. To this end a real-time digital control system²¹ performs a continuous read-out of the interferometer signals at 20 kHz and acts on the mirror position at 10 kHz.

The design sensitivity of Virgo is shown in figure 3. Also shown on the same plot are some of the expected signals from potential astrophysical sources. Several uncertainties affect the estimation of the amplitude of gravitational waves emitted by astrophysical sources such as star core collapses and rotating neutron stars. More precise estimates exist in the case of coalescing binary; in this case Virgo, operating at its design sensitivity, would be able to detect signals coming from regions of the universe as far as 30 Mpc thus including the Virgo cluster.

3 Status of Virgo

Virgo has been built at the European Gravitational Observatory (EGO) near Pisa, Italy, by a French-Italian collaboration supported by INFN and CNRS⁷. The construction of the central

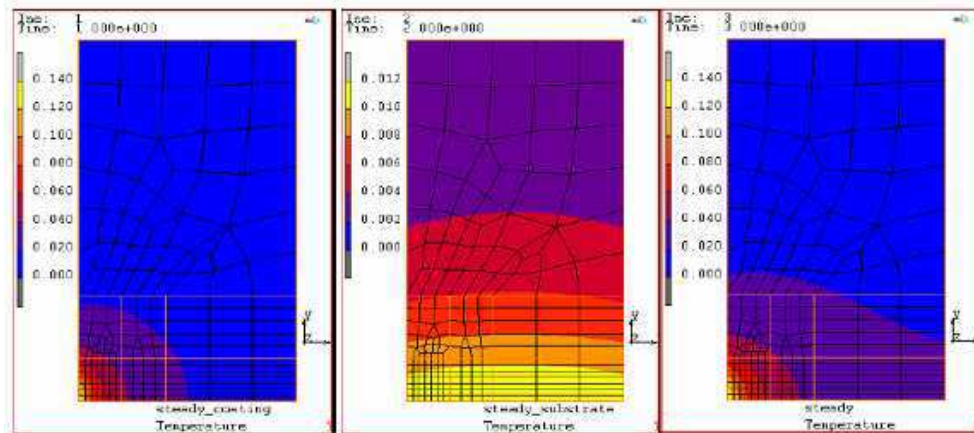

Figure 4: A Virgo optic with surface and substrate heating. The resulting thermal lens changes the properties of the recycling cavity.

area (including the central building, the mode-cleaner building and the control building) started in 1996 and was completed in 1998. The central part of the detector was installed and commissioned between 1999 and 2002 using small mirrors²². During that period the two arms and the terminals buildings were constructed and the 3 km long vacuum tubes were installed. In the summer of 2003 the last large mirror was installed thus allowing the beginning of the commissioning phase. This phase culminated in the C6 and C7 commissioning runs, in which the detector gathered data continuously for a total of 19 days. After C7, in the winter of 2005 three major hardware changes were made: the power recycling mirror was replaced, the suspended bench containing the input mode-cleaner and other optics responsible for delivering the laser beam to the interferometer was replaced, and the laser power incident on the interferometer was increased to about 8 Watts. The second long commissioning period began in the spring of 2006 and ended in May, 2007, with the start of the first Virgo science run in which data will be gathered continuously for 4 months. This last period, leading up to the science run, is discussed in some detail in the following sections.

3.1 Commissioning of the detector

Primary activities during the year of commissioning before the on-going science run were: obtaining stable control of the interferometer at the operating point, and reduction of noise in the output port signal (e.g., the signal where gravitational waves should appear) known as “noise hunting”.

Before the final shutdown, during C7, the interferometer control system was able to hold it at the working point. The increased power, intended to improve the interferometer sensitivity at high frequency, had the unwanted and unexpected consequence of heating the optics to the point of creating problematic levels of thermal lensing (see figure 4). By modifying the fields in the recycling cavity, the heating of the optics destabilized the interferometer control system. Developing a stable control system, in the presence of thermal lensing and the absence of thermal compensation, was one of the greater commissioning challenges of this period.

Once the interferometer could be controlled with reasonable stability, noise hunting work began. As shown in figure 5, many noise source contribute to the interferometer sensitivity curve. At high frequencies, above 1 kHz, the dominant noise is shot noise. The measured noise is within 20% of the expected noise level, and other source (e.g., laser frequency noise) dominate only in a few narrow frequency bands.

At frequencies below 50 Hz, the largest contributors are self-inflicted control noises. The

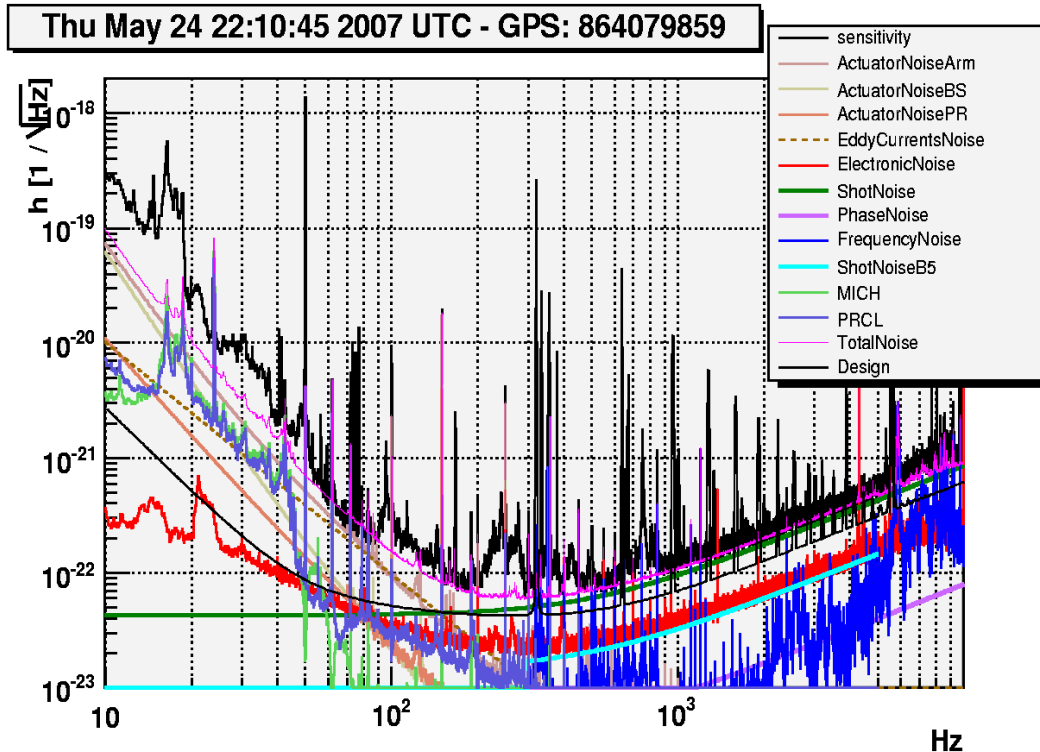

Figure 5: The Virgo noise budget, showing the main contributors as of the start of the science run. The incoherent sum of all noises is slightly above the measured noise around 70 Hz, most likely due to an overestimate of the eddy current noise.

worst of these comes from the control of the small Michelson interferometer (made up of the NI, WI and BS, shown in figure 1), which has a noisy error signal and produces a signal at the interferometer output port. By reducing control noises and their coupling to the output port, this and other control noises were made to dominate only in the region below 50 Hz.

In the mid-frequency region, there is a mix of noises sources. In the Virgo design curve (recall figure 3), this region is mostly dominated by shot noise, with thermal noise taking over below 80 Hz. If not properly tuned, noises normally limited to the high and low frequency regions can become dominant in this region. Even when all is working well, the mid-frequency region is plagued by acoustic, electromagnetic, and other environmental noise source which couple into the interferometer often in somewhat mysterious ways. Small noise bursts, or "glitches", can also be produced at the interferometer output port by dust particles passing through the laser beam between its exit from the vacuum and its encounter with the photo-detectors.

Many of these environmental noises were addressed in the last 6 months of this year of commissioning. Acoustic noise couplings were reduced by the addition of acoustically isolating enclosures, and both general and directed adjustments of the optics used on the in-air optical benches. Electromagnetic noise couples through a known flaw in the input mirror construction (NI and WI) which could not be addressed, so noisy electronics were simply disabled or moved away from these sensitive points.

Starting in September 2006, occasional "weekend science runs" were held to provide data for analysis, experience with science-mode running, and milestones in sensitivity progress. The sensitivity curves from WSR1 through WSR10 are shown in figure 6. The Virgo science run began 18 May 2007, thus marking the end of all but small scale commissioning activities.

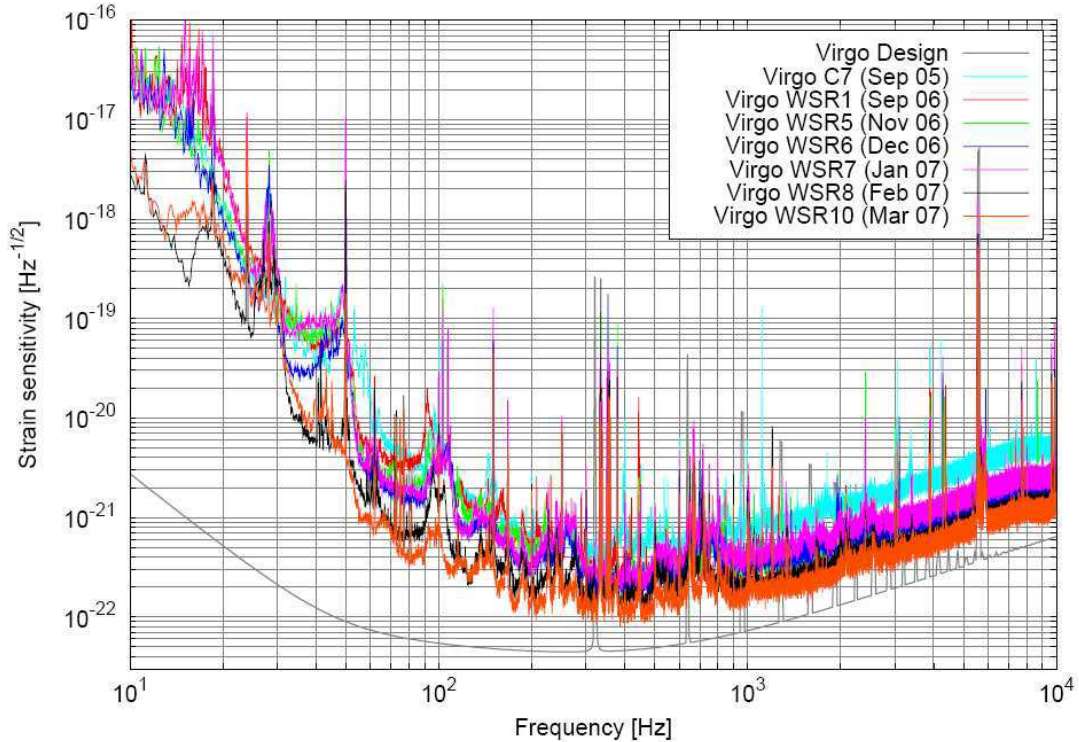

Figure 6: Sensitivity curves from various weekend science runs. The Virgo design curve, and the C7 sensitivity, are shown for reference.

3.2 Data analysis preparation

The setting up of the data analysis pipelines has started several years ago. The detector produces about 6 to 8 MB/s of compressed data that, integrated over one year correspond to about 200 to 250 TB of data. This explains the need of having all the data analysis pipelines well in place before the long data taking is started.

This preparation of the data analysis pipelines have been considerably accelerated as the commissioning of the interferometer started and real technical data became available. One of the main difficulties encountered when analyzing real data has been the need to deal with the non stationarity of the interferometer noise.

The data analysis preparation consists of several activities. The main core of the work consists in the development and test of search algorithms for each class of sources. The algorithms are first tested against simulated data. In a second step they are tested on real data using either hardware injections i.e. fake gravitational wave like signals injected in the interferometer using the coils-magnets actuators or software injection i.e. fake signals added to the data once they have been collected. Before the algorithms could run on the data the interferometer output needs to be calibrated and the strain signal reconstructed. This is done by measuring the frequency response of the interferometer and monitoring the evolution of this calibration curve as a function of time.

Another important part of the work consists in the development of vetoes to reduce the false alarm rate. Different kind of vetoes are used: epoch vetoes based on the state of the interferometer are applied a-priori before the algorithms are run on the data while a-posteriori vetoes that use the output of the search algorithms are instead applied at the end of the process. Finally vetoes are developed using auxiliary channels that monitors the various interferometer sub-systems, the interferometer control systems as well as the environmental noise. The vast

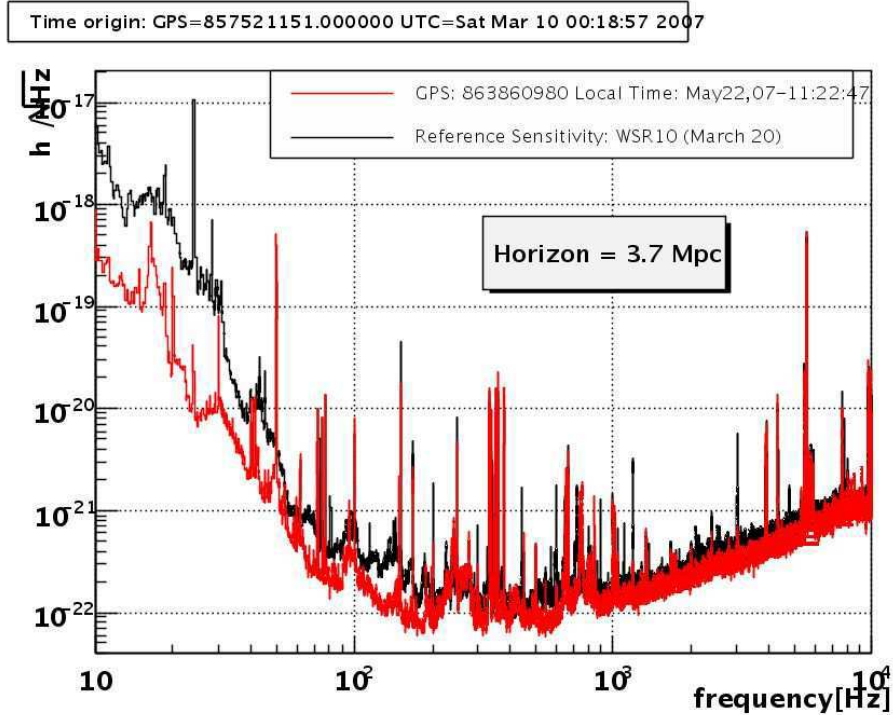

Figure 7: Sensitivity curve at the start of VSRI, with the curve from WSR10 shown for comparison.

majority of the channels acquired (≈ 1500) are collected for this purpose.

The ultimate method to distinguish between a fake effect and the detection of a gravitational wave is the observation of coincident signals at the output of several widely spaced detectors. Since the earth is transparent to gravitational waves, these are expected to produce similar signals on all detectors on earth, the differences being due to the detector orientations and to the time delay related to the distance between the detectors. The coincident observation in at least three detectors of the same event and the measurement of the three time delays is a necessary condition to reconstruct the source location. For this reason the exchange of data and their analysis in coincidence is a usual practice in this field and all the experiments are using the same data format.

In this context the Virgo collaboration is preparing the analysis of the data in coincidence with the LIGO interferometers since a couple of years. The first step has been the joint analysis of simulated data produced by the Virgo and LSC collaborations. These studies have shown that adding Virgo to the LIGO network permits an increase of the detection efficiency by 30% to 50% depending on the kind of source^{24,25}. In parallel with this preparatory work, an MOU has been signed between VIRGO and LIGO. The agreement foresees full data exchange, joint data analysis, and joint publications.

4 Conclusions

The commissioning of Virgo with 8 W of injected laser power started in 2006 and ended 18 May, 2007, with the initiation of the first Virgo science run. At the start of the run, the detector sensitivity expressed in terms of the maximum distance at which a coalescing binary formed by two neutron stars would be detectable attained 3.7 Mpc i.e. a factor of eight below the design sensitivity (see figure 7). In the initial 2 weeks of the run, the science mode duty-cycle is

slightly higher than 85%. The science run is expected to last for 4 months, and will be followed by a set of medium scale upgrades called Virgo+, and later by more significant changes called Advance Virgo, both discussed elsewhere in these proceedings. A joint VIRGO-LIGO data analysis program has been formalized, and data exchange is expected to begin soon. During the next few years Virgo will participate to the world-wide search for gravitational waves. The on-going and forthcoming R&D is aimed at substantial upgrades of the present detectors that during the next decade which will extend the search for gravitational waves to distances in the 100 Mpc to 1 Gpc range, almost certainly making detection a common occurrence.

References

1. C.W. Misner, K.S. Thorne, J. Wheeler; Gravitation, Freeman W. H., S. Francisco (1973)
2. K.S. Thorne; Gravitational Radiation in: 300 Years of Gravitation, Cambridge University Press, Cambridge (1987)
3. J.M. Weisberg and J.H. Taylor; Physical Review Letters 52 1348 (1984)
4. G. Pizzella in 'The detection of gravitational waves', D.G. Blair Editor, Cambridge, University Press (1991).
5. R. Weiss, Quarterly Progress Report of the Research Laboratory of Electronics, MIT 105 (1972) 379
6. <http://www.ligo.caltech.edu>
7. <http://www.virgo.infn.it>
8. <http://geo600.uni-hannover.de>
9. R.W.P. Drever in: Gravitational Radiation, Proc. Les Houches Summer Institute, eds. T.Piran and N.Deruelle (North-Holland, Amsterdam, 1982) p.321
10. F. Beauville et al.; Class. Quant. Grav. 21 (2004) S935-45
11. F. Bondu et al., Class. Quant. Grav. 19 (2002) 1829
12. F. Beauville et al., Class. Quant. Grav. 23 (2006) 3235-3250
13. R. Flaminio, Nucl. Instrum. Methods A 409 (1998) 477
14. G. Ballardini et al., Rev. Sci. Instrum. 72 (2001) 3643
15. G. Losurdo et al., Rev. Sci. Instrum. 70 (1999) 2507
16. S. Braccini et al., Rev. Sci. Instrum. 67 (1996) 2899
17. S. Braccini et al. ; Rev. Sci. Instrum. 66 (1995) 2672
18. H. Tariq et al., Nucl. Instrum. Methods A 489 (2002) 570
19. G. Losurdo et al., Rev. Sci. Instrum. 72 (2001) 3653
20. A. Bernardini et al., Rev. Sci. Instrum. 70 (1999) 3463
21. F. Cavalier, 'Le contr?le global de Virgo' These d'habilitation a diriger des recherches, Universite Paris Sud, LAL 01-69 (2001)
22. F. Acernese et al., Astroparticle Phys. 21 (2004) 1
23. F. Acernese et al, Class. Quant. Grav. 23 (2006) S85
24. F. Beauville et al., Class. Quant. Grav. 22 (2005) S1293
25. F. Beauville et al., Class. Quant. Grav 22 (2005) S1149
26. R. Flaminio et al., 'Advanced Virgo White Paper', VIR-NOT-DIR-1390-304
27. Virgo Collaboration, 'Guidelines for Advanced Virgo R&D' VIR-NOT-DIR-1390-325