



HAL
open science

The advancement of SPIRAL 2 project

Pierre Bertrand, M.H. Moscatello

► **To cite this version:**

Pierre Bertrand, M.H. Moscatello. The advancement of SPIRAL 2 project. 18th International Conference on Cyclotrons and their Applications - Cyclotrons 2007, Oct 2007, Giardini-Naxos, Italy. pp.39-41. in2p3-00339996

HAL Id: in2p3-00339996

<https://hal.in2p3.fr/in2p3-00339996>

Submitted on 21 Nov 2008

HAL is a multi-disciplinary open access archive for the deposit and dissemination of scientific research documents, whether they are published or not. The documents may come from teaching and research institutions in France or abroad, or from public or private research centers.

L'archive ouverte pluridisciplinaire **HAL**, est destinée au dépôt et à la diffusion de documents scientifiques de niveau recherche, publiés ou non, émanant des établissements d'enseignement et de recherche français ou étrangers, des laboratoires publics ou privés.

THE ADVANCEMENT OF SPIRAL 2 PROJECT

P. Bertrand, M.H. Moscatello, GANIL, Caen, France
on behalf of the SPIRAL 2 team.

Abstract

After a detailed design study phase (2003-2004), the SPIRAL2 project at GANIL (Caen, France) was officially approved in May 2005, and is now in its phase of construction, with a project group in which many French laboratories (CEA, CNRS) and international partners are participants. The SPIRAL2 facility is composed of a multi-beam driver accelerator (5mA/40Mev deuterons, 5mA/33Mev protons, 1mA/14.5 Mev/u heavy ions), a dedicated building for the production of radioactive ion beams (RIBs), the existing cyclotron CIME for the post acceleration of the RIBs, and new experimental areas. It will deliver high intensity beams for radioactive ion production by the ISOL method (the main process being the fission of a uranium carbide target), and stable heavy ions for nuclear and interdisciplinary physics. A high intensity neutron flux will also be produced for irradiation and time-of-flight experiments. In this paper we describe the various parts of this facility, the results obtained with prototypes of several major components, the status of the construction itself, and the research and development which remains to be done in some domains, including safety aspects.

INTRODUCTION AND OPPORTUNITIES FOR PHYSICS EXPERIMENTS

A strong demand exists for availability of radioactive isotope beams. NuPECC and ESFRI have established roadmaps and given recommendations for the future of nuclear physics and facilities in Europe. SPIRAL2 is one of the selected projects.

This new facility will extend the possibilities offered at GANIL to heavier radioactive beams, with much higher intensities [1]: it will provide intense beams of neutron-rich exotic nuclei (10^6 – 10^{11} pps), created by the ISOL production method, in the mass range from $A=60$ to $A=140$. The extracted exotic beam will be used either in a new low energy experimental area called DESIR, or accelerated by the existing SPIRAL 1 cyclotron (CIME).

The intense primary stable beams (deuterons, protons, light and heavy ions) will also be used at various energies for neutron-based research, irradiation and activation studies and multi-disciplinary research, all these experiments taking place in a new area (AEL).

Originally proposed in June 2002 [2], and after detailed design studies [3][4][5], SPIRAL2 was accepted in May 2005, and is now in its construction phase, with the objective of obtaining the first beams for physics by the end of 2011. Many French laboratories participate in the construction of the SPIRAL2 facility, and there are numerous European and international collaborations, either for the accelerator itself or for which the physics areas.

In what follows, we give a description of the main parts of the machine, and the status of its construction.

SPIRAL2 DRIVER ACCELERATOR AND AEL EXPERIMENTAL AREA

Beams to be accelerated

In order to fulfil the physics requirements, the SPIRAL2 driver accelerator must be able to accelerate high-intensity beams of protons, deuterons, ions with $A/q < 3$, and optionally ions with $A/q < 6$. As indicated in table 1, a maximum beam power of 200kW is required for deuterons in CW mode. In order to transport and accelerate these intense beams with a minimum of losses, many beam dynamics calculations have been performed all along the machine, by using realistic source particle distributions, real 3D magnetic fields, compensation space charge effects in various situations, and also with systematic errors studies [6][7]. The whole driver accelerator will be controlled using the EPICS software [8] coupled with the TRACEWIN/PARTRAN code in order to implement the notion of a “virtual machine”.

Table 1: Beam Specifications

beam	P+	D+	ions	ions
Q/A	1	1/2	1/3	1/6
Max. I (mA)	5	5	1	1
Min. output W (Mev/A)	2	2	2	2
Max output W (Mev/A)	33	20	14.5	8
CW Max. beam power (KW)	265	200	44	48

Injector-1

The Injector-1, dedicated to protons, deuterons and ions of $q/A=1/3$, is mainly composed of two ECR ion sources with their associated LEPT lines, a warm RFQ and the MEBT line connected to the LINAC.

The 2.45GHz ECR source for deuterons is a “simplified” SILHI-like source (100mA CW, 95kV), initially developed by the CEA/DAPNIA laboratory for the IPHI project [9]. In 2005, the Saclay source demonstrated its capability to produce a very stable 6.7mA D^+ CW beam with an rms normalised emittance less than 0.1π .mm.mrad. It will also produce protons (5mA) and H_2^+ , with a voltage of 20kV for protons and 40kV for D^+ and H_2^+ ($\beta=0.0067$). The ECR source for SPIRAL2 is now under construction.

The objective for SPIRAL2 is also to produce a large diversity of heavy ions with intensities up to 1mA: noble gases like Ar^{12+} , and metallic ions like Cr, Ni and Ca are

required. During the initial DDS phase, an R&D program was conducted to measure the performances of the PHOENIX ECR heavy ion source from the LPSC laboratory (Grenoble), and in particular to measure the transverse emittances obtained for 1mA of O^{6+} at 60kV ($0.22 \pi \cdot \text{mm} \cdot \text{mrad}$ rms norm.).

In parallel, a new ECR source design has recently been proposed by the LPSC: the so called "A-Phoenix" source [10]. It is a compact hybrid ECRIS with high-temperature superconducting (HTS) coils (3T axial magnetic field) and a permanent-magnet design (2T hexapolar field). With a 28-GHz frequency, the goal is to approach 1-mA intensity for an Ar^{12+} ion beam. The components of the source are now assembled and the first plasma tests are being performed presently.

Both light and heavy-ion ECR sources have their own chromatic transfer line able to separate the species extracted from the source and select the desired purified beam. These lines are connected to a common LEPT which contains a slow chopper, diagnostics and slits to redefine the emittance before connection to the RFQ. The magnetic elements are being manufactured, and their magnetic measurements will start by the end of 2007.

Developed by the CEA/DAPNIA team, the RFQ [11] is a 4-vanes, 5-meter warm copper cavity ensuring adiabatic bunching (88Mhz) of the continuous beam, and acceleration at 0.75MeV/u ($\beta=0.04$). It is specially designed to give a transmission of better than 99%. A 1-meter segment prototype was built during the APD phase and tested at Grenoble and Catania in order to check the feasibility. The construction of the RFQ is now starting and will take about two years.

The RFQ cavity requires some 150kW and will be driven by four 50kW amplifiers equipped with circulators [12]. Digital low-level RF will ensure 10^{-2} and 1° amplitude and phase stability respectively. The CEA/DAPNIA team in charge of the LLRF is studying a standard card which will be used to control all types of cavities along the accelerator (RFQ, rebunchers and SC LINAC resonators).

The MEPT line takes care of the beam transmission and matching between the RFQ exit and the LINAC entrance. Its function is also to allow future connection of the injector-2, and to operate a very clean fast chopping of the beam bunches for various AEL experiments. This explains the length of this part (8m) and the necessity to use three rebunchers in order to match the beam longitudinally. Most of the devices are completely designed and will be ordered very soon. One exception is the challenging fast chopper and its associated 7.5kW beam stopper, which are under detailed study [13].

Due to delays concerning the construction of the accelerator building, the whole of Injector-1 will be installed at Saclay and tested with beam, before being transported to GANIL. In addition, a specific medium-energy diagnostic plate is under construction in order to prepare the beam commissioning of the RFQ and of the MEPT during this first phase, and to test various diagnostic devices on line. Associated with a phase length

monitor, the first rebuncher will be used to determine the longitudinal emittance of the RFQ.

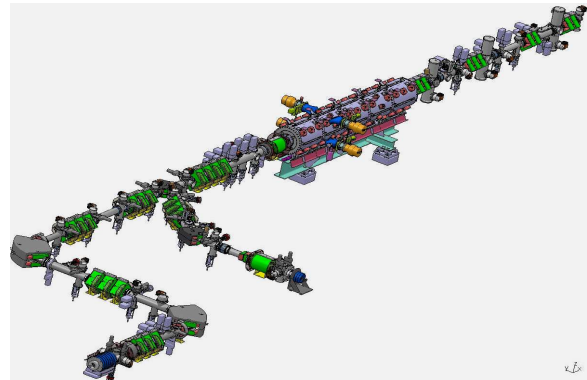

Figure 1: View of injector-1 (LEPT, RFQ and MEPT)

Injector-2

The optional Injector-2 will be dedicated to $q/A=1/6$ heavy ions connected to the LINAC via the MEPT line. This injector is under detailed study in order to prepare enough space in the accelerator building for the future. Although it will give only half the energy compared to Injector-1, there is much interest in having higher beam intensity for very heavy ions. A design study is being conducted in the frame of a MoU with the Argonne laboratory.

Linac

The LINAC accelerator itself is based on superconducting independently-phased resonators [14]. It is composed of 2 families of quarter-wave resonators (QWR) at 88MHz, developed respectively by the CEA/DAPNIA and the IN2P3/IPNO teams: 12 resonators with $\beta_0=0.07$ (1 cavity/cryomodule [15]), and 16 resonators at $\beta_0=0.12$ (2 cavities/cryomodule [16]). The transverse focusing is ensured by means of warm quadrupole doublets located between each cryomodule. These warm sections include also beam diagnostic boxes and vacuum pumps.

The maximum reference gradient of the QWRs is $E_{acc}=V_{acc}/\beta\lambda=6.5\text{MV/m}$. Two prototypes QWR1 and QWR2 were constructed during the initial R&D phase. Installed in vertical test-cryostats, both resonators reached very high gradients, between 9 and 11MV/m. The first pre-series cryomodules are being assembled, and complete tests with cavities will be achieved by the end of 2007.

Developed by IN2P3/LPSC (Grenoble), the RF power couplers have to provide 12kW CW power to each cavity [17]. Two coupler prototypes, using either disk or cylinder ceramic window geometries, were also constructed. Both prototypes have reached CW power levels greater than 30kW, giving a good margin for the nominal operation power levels. The series of couplers will be ordered by the end of this year.

Solid-state amplifiers will be used, and first prototypes of 10 and 20 kW have recently been tested at GANIL

[18]. These amplifiers are based on latest transistors for FM applications and water cooling allows us to use four 3kW racks for each 10kW cabinet. Power tests on the cryomodules will help us to choose the best compromise between the required gain linearity and the working class. An operating efficiency around 55% is expected.

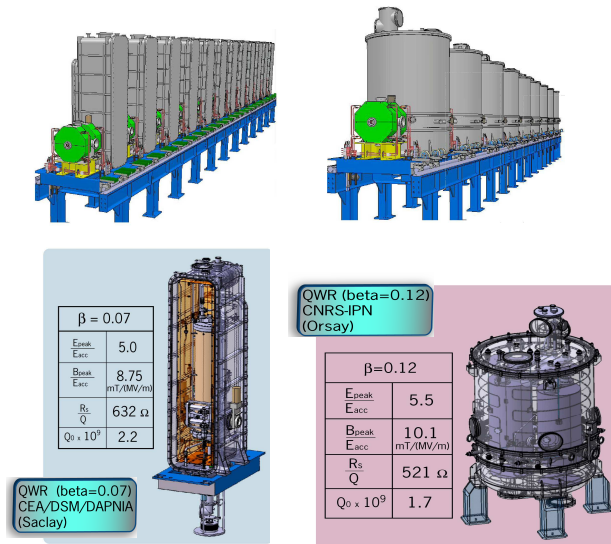

Figure 2: The SPIRAL2 superconducting cryomodules (left: $\beta_0=0.07$, right: $\beta_0=0.12$)

HEBT lines an AEL experimental hall

The high energy beam transfer lines (HEBT) are divided into three main parts:

- LEBT1: A straight beam line with a beam dump is needed for the beam commissioning and eventual tuning and beam studies. The beam dump can handle a maximum beam power of 200kW. Depending on nuclear safety licensing requirements, mainly related to the material activation, the effective beam power will depend on ion species.

- LEBT2: This transfer line will transport light- and heavy- ion beams towards the two RIB production areas, located in a separate building. (see next section).

- LEBT3: These lines will deliver the beams to the AEL experimental hall, installed in the same building as the driver accelerator. Three subsidiary beam lines must deliver light and heavy ions to three large experimental rooms: a) for neutron experiments where a neutron time-of-flight facility will be installed, b) for high-intensity stable ions experiments where a spectrometer with high mass selectivity will be installed, and c) an interdisciplinary experimental area for atomic physics and material studies.

The LEBT3 contains several rebunchers in order to keep the beam bunched, with a bunch length as small as possible at the target (<1ns). Various targets will be used, in particular actinides, which necessitate special safety procedures for manipulation.

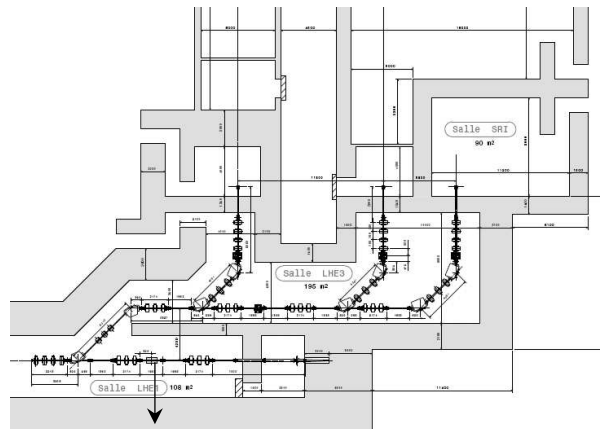

Figure 3: View of the AEL beam lines (up) and line towards the RIB production (bottom)

SPIRAL2 RADIOACTIVE BEAM AREA

The studies on the radioactive beam area have been progressing since the beginning of the SPIRAL2 construction phase [1], and have led to new solutions, both in the general layout and in the mechanical design of the target/ion-source (TIS) system and the beam transport lines.

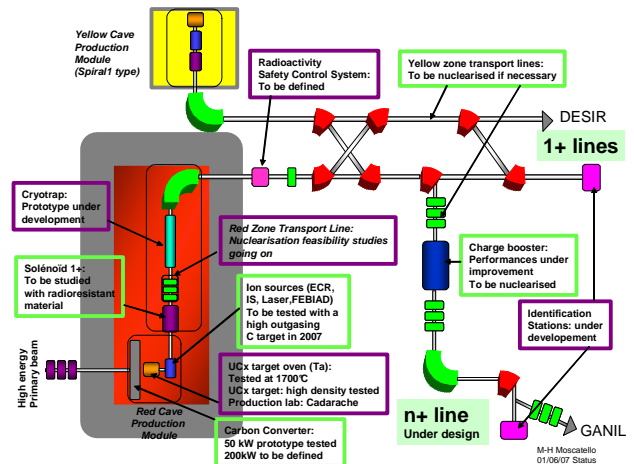

Figure 4: Principle scheme for the RIB part

TIS production system

The main TIS system of SPIRAL2 is based on the use of a carbon converter for the production of neutrons from the 5mA 20A.MeV deuteron beam combined with a uranium carbide target in which the neutron flux produces fission reactions, and thus a very large variety of radioactive isotopes.

- Carbon converter target: the new design is based on the one developed for the SPES project [19], in the frame of the collaboration with the LNFN/LNL and BINP/Novosibirsk laboratories. A graphite prototype has been tested with a 50-kW electron beam: some improvements are still needed, in particular of the bearings, in order to validate the technical solution for a first step. A test bench for the development of these bearings is being designed and is to be built before the

end of the year, while the 200-kW target is under thermo-mechanical design.

- Uranium carbide target: the target geometry has been optimised, and the best compromise has been chosen: a 2.2-kg high-density target (11g/cm^3) for a production of 5.10^{13} fissions/s [20]. The high-density target development is taking place in the frame of the PLOG collaboration, and very important results have been obtained this last year: the 11g/cm^3 target is as rapid as the normal density one for the atom release, and the effect of the grain size on the release time has been demonstrated as well: the optimum seems to be around $25\mu\text{m}$ [21].

- Four types of 1+ ion sources are planned. The main developments of the 1+ ion sources concern their resistance to the highly radioactive environment, and the high reliability level requirement, as irradiation periods are planned to be around 3 months long. The ECR ion source “Monobob” is undergoing tests and improvements at GANIL [22], the FEBIAD ion source “IRENA” is under development as well at IPN Orsay [23]. A surface ionisation source is also being developed [24], while some collaboration has to be implemented for the design of the laser ion source.

- The TIS production module has been totally redesigned, taking into account the numerous constraints given by the radiological environment and the safety and contamination handling rules. The production module is a totally remote-operated system, which will be disconnected, transported into the hot cell for maintenance and TIS replacement, and reconnected by a robot and manipulator system. Its general mechanical design is illustrated in Fig.5.

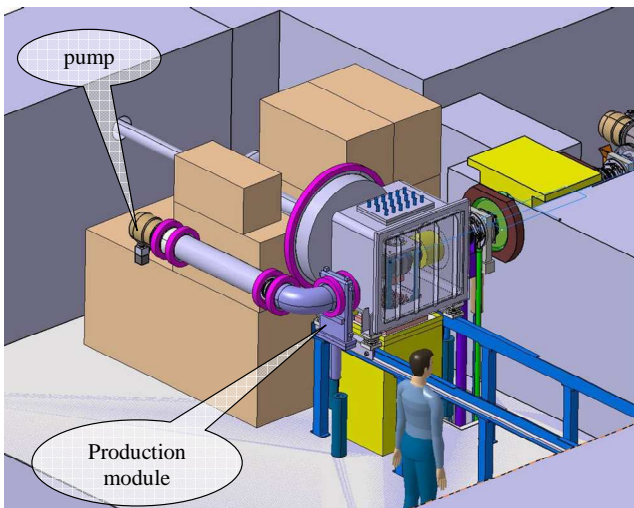

Figure 5: Spiral2 UCx production module

Several other kinds of TIS will be developed in the coming years and during the facility’s life, using several different reactions types (deep-inelastic, transfer, fusion-evaporation), different beams and targets. The first TIS system under development is based on the fusion-evaporation reaction type, and is being designed in the IN2P3/CENBG laboratory. The main technical challenge concerns the thermal design of the target, which has to

withstand very high power densities (several $100\mu\text{A}$ beams).

Beam transport lines to DESIR experimental area and to existing GANIL areas

The radioactive beam transport lines from both production caves towards the experimental areas have been designed from the beam-optical viewpoint. A general implantation scheme is proposed in Fig.6, and the detailed study has still to be started in close collaboration with the building technical design team.

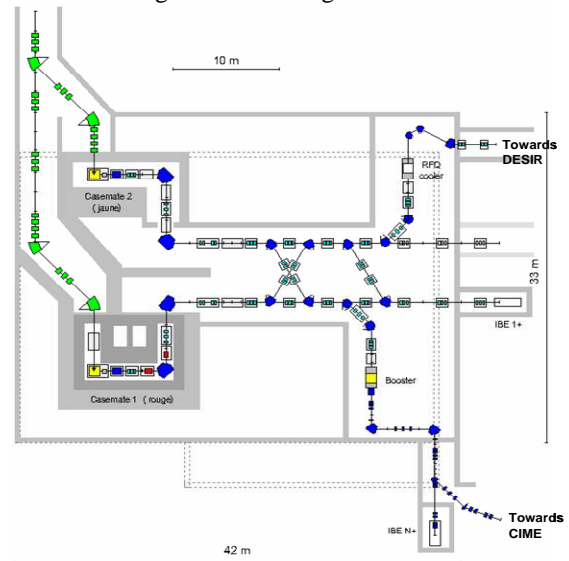

Figure 6: Beam-optical layout for the RIB transport lines in the production building

The 1+ line, going from the ion sources towards an identification station (IBE1+), the low-energy experimental area DESIR or the charge booster will include both electrostatic and magnetic components. The mechanical design of the line is based on the use of independent modules that will be extracted with remotely operated tools from inaccessible places like the production caves, around the charge booster, and in any zone where radioactivity and/or contamination will become important. A preliminary technical proposal for the modules is presented in Fig. 7.

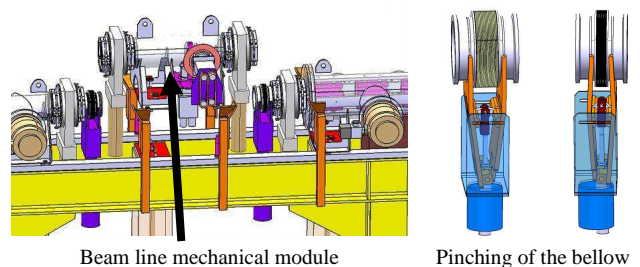

Figure 7: Details of beam line remote-controlled modules

The charge booster, needed to inject the RIB into the CIME cyclotron, is a Phoenix type developed by the LPSC laboratory [25]. Charge breeding has been tested on

the LPSC test bench with the MONOBOB ECR 1+ source for argon krypton and xenon beams, together with the tuning procedure to pass from the stable reference beam to the radioactive one. It is now to be tested for light-ion beams first, and then with metallic ions for which we know that the V tuning is very sharp.

The n+ line that transports the beam from the charge booster to CIME cyclotron is under optical and mechanical design, and will first be constructed without remote-operated modules, but with mechanical interfaces that will allow us to add remote-operated valves and bellows in the future, when the RIB intensities reach the nominal values.

Production building and safety aspects

The production building, which will host the RIB production cave and the RIB transport lines will be a nuclear type building. The safety requirements imply a double confinement in the whole building that will host the UCx production cave as well as the transport lines for the radioactive beams composed of fission products [26]. The whole vacuum system will be connected to the gas storage system, and a public enquiry will be launched to get the authorization to release gas from the storage facility, after a suitable period of radioactivity decrease.

ACCELERATION OF THE RIBs IN CIME CYCLOTRON AND USE OF THE EXISTING EXPERIMENTAL AREAS

Safety issues and Intensity limitations

The SPIRAL2 RIBs will either be used at low energy in the DESIR experimental area, or accelerated by the existing CIME cyclotron. The CIME cyclotron has been constructed in the frame of the SPIRAL project, and at that time only the production of rather light ions (up to krypton) and very short-lived elements was considered. Thus, the problematic of long-range radioactivity and contamination deposited inside the low-energy beam lines or in the cyclotron centre (where the inflector itself intercepts 50% of the beam) had been totally ignored at that time. With the SPIRAL2 project, and the use of long-lived fission products, one of the main issues is due to the beam losses inside the cyclotron (and in a lesser extent inside the low-energy beam lines). The different centres which are used for the different harmonic tunings are frequently changed, with manual mounting and dismantling mechanical operations, and sometimes somewhat uncomfortable positions for the operators. A detailed study is under way to evaluate precisely what the level of potential contamination along the existing GANIL equipments will be, from the low-energy beam lines, through the CIME cyclotron, to the experimental areas. Important mechanical modifications will have to be made, in order to be able to disconnect and reconnect equipment very quickly and if possible with remotely operated tools. Hopefully, higher energy implanted atoms should be released much less than at low energy or not at all. Nevertheless, one has also to consider accidental

cases, the major one being the case of fire inside the caves. In that unfortunate case, the facility will have to remain totally safe, especially for the public area. All these considerations might lead to some intensity limitations, especially for highly contaminating elements (i.e. iodine nuclei), or for elements which decay on daughter nuclei which are themselves highly contaminating (i.e. Sn nuclei that decay to iodine).

Acceleration of RIBs in CIME cyclotron

Another issue in the acceleration of RIBs in CIME cyclotron concerns the separation of the different isobars inside the cyclotron. The RIBs produced in SPIRAL2 will have higher masses, and thus will have much lower differences in $\Delta m/m$ and very small differences in phase position at the cyclotron extraction (Table 2).

Table 2: Mass separation and phase difference at the CIME extraction for different isobars

Element	A	Q	dq/A	Element	A	Q	dq/A	Element	A	Q	dq/A	$d\phi$ (°)
Kr	91	20	0.00	Cs	132	20	$8.58 \cdot 10^{-5}$	Ba	144	20	$-2.33 \cdot 10^{-5}$	-3.4
Mo	91	20	$1.28 \cdot 10^{-4}$	I	132	20	$7.39 \cdot 10^{-5}$	Ce	144	20	$4.13 \cdot 10^{-5}$	+6
Nb	91	20	$1.81 \cdot 10^{-4}$	In	132	20	$-1.11 \cdot 10^{-4}$	Cs	144	20	$-8.64 \cdot 10^{-5}$	-12.5
Rb	91	20	$7.60 \cdot 10^{-5}$	Sb	132	20	$2.69 \cdot 10^{-5}$	Eu	144	20	$5.57 \cdot 10^{-6}$	<-1
Ru	91	20	$-3.27 \cdot 10^{-5}$	Sn	132	20	0.00	La	144	20	0.00	0.00
Sr	91	20	$1.45 \cdot 10^{-4}$	Te	132	20	$6.99 \cdot 10^{-5}$	Nd	144	20	$6.61 \cdot 10^{-5}$	+9.6
Tc	91	20	$5.47 \cdot 10^{-5}$	Xe	132	20	$1.03 \cdot 10^{-4}$	Pm	144	20	$4.87 \cdot 10^{-5}$	+7
Y	91	20	$1.77 \cdot 10^{-4}$					Sm	144	20	$5.28 \cdot 10^{-5}$	+7.6

The use of additional separation systems will thus be necessary. A vertical separator placed inside the cyclotron has been developed at GANIL [27] which will allow us to separate most of heavy ions (down to $\Delta m/m \sim 10^{-5}$) from SPIRAL2.

Some new diagnostics will be also necessary, the gas beam profilers used presently in SPIRAL facility having a limited mass range (due to the thickness of the window).

CONCLUSION

The major parts of the injector and the superconducting SPIRAL2 accelerator are now under construction. The philosophy and structure of the HEBT lines are being completed in order to take into account the latest evolutions of the AEL experimental hall and the connection to the production area. The design of the building is under way and its construction will start in 2009. After installation and beam tests at Saclay, the injector-1 will be transported and installed at GANIL, in parallel with the LINAC and the HEBT lines. The full beam tests should take place by the end of 2011.

The radioactive beam area is still in a preliminary design study phase. The final detailed design solution for the process equipment (TIS, transport systems) depends essentially on the detailed design study of the production building that will be done by a nuclear engineering company from 2008. In addition, the necessary modification of the existing GANIL facility might also lead to some major work, but one can hope to be allowed to start with reduced RIB intensities, compatible with the present facility from the safety point of view.

AKNOWLEDGEMENT

The authors address their thanks to the whole SPIRAL2 project team, which is based on a very wide collaboration with French nuclear physics laboratories, as well as with European and international organisations.

REFERENCES

- [1] MG Saint-Laurent on behalf of the Spiral2 project group, "Future opportunities with Spiral2 at GANIL", AccApp07, Pocatello, Idaho, July 30-August 2nd, 2007
- [2] W. Mittig et al., "LINAG Phase 1", GANIL internal report, June 2002
<http://www.ganil.fr/research/sp/reports>
- [3] A. Mosnier, "SPIRAL2: a high intensity deuteron and ion linear accelerator for exotic beam production", PAC 2003, Portland, USA, May 2003, p.595
- [4] MH Moscatello for the SPIRAL2 project group, "SPIRAL2 at GANIL", Cyclotron 2004, Tokyo, October 18-22, 2004, p518-522
- [5] T. Junquera, P. Bertrand, R. Ferdinand, M. Jacquemet, "The high intensity superconducting linac for the spiral2 project at GANIL", LINAC 2006, Knoxville, Tennessee, USA.
- [6] J.L. Biarrotte, P. Bertrand, D. Uriot, "Beam dynamics studies for the spiral2 project", EPAC 2006, Edinburgh, Scotland.
- [7] R. Duperrier, D. Uriot, "Application of the extreme value theory to beam loss estimates in the SPIRAL2 linac based on large scale Monte Carlo computations", Phys. Rev. ST Accel. Beams 9, 044202 (2006)
- [8] E. Lecorche et al. "First steps towards the new SPIRAL2 project control system", ICALEPS 2007, 15-16 October, Knoxville, USA.
- [9] R. Gobin et al, "Development of a permanent magnet ECR source to produce a 5mA deuteron beam at CEA/Saclay", LINAC 2004, Lübeck, Germany.
- [10] T. Thuillier, T. Lamy, L. Latrasse, J. Angot, "First plasmas of the A-Phoenix ECR ion source, 12th ICIS, August 2007, Jeju, Korea.
- [11] R. Ferdinand et al, "Spiral2 RFQ design", EPAC 2004, Luzern, Switzerland, July 2004.
- [12] M. Di Giacomo et al., "Status of the RF systems for the spiral2 linac at the beginning of the construction phase", LINAC 2006, Knoxville, Tennessee USA.
- [13] G. Ledem, M. Di Giacomo, "A single bunch selector for the new low continuous wave heavy ion beam", PAC2007, Albuquerque, New Mexico, USA.
- [14] R. Ferdinand et al. "Status of the cryomodules for the spiral2 superconducting linac", PAC2007, Albuquerque, New Mexico, USA.
- [15] P. Bosland et al. "Low-beta SC quarter wave resonator and cryomodule for spiral2", PAC 2005, Knoxville, Tennessee, USA.
- [16] T. Junquera et al. "High intensity driver for the spiral2 project: design of superconducting 88-Mhz quarter wave resonators (beta=0.12), power couplers and cryomodules", EPAC 2004, Lucerne, Switzerland.
- [17] Y. Gomez Martinez et al, "Theoretical study and experimental result of the RF coupler prototypes of Spiral2", EPAC 2006, Edinburgh, Scotland.
- [18] M. Di Giacomo et al. "The test bench for the power amplifiers of the spiral2 SC linac", Proceedings of the 13th International workshop on RF superconductivity, October 2007, Beijing, China.
- [19] L.B. Tecchio, "Design of a high power Neutron converter for Spiral2", EMIS 2007, Deauville, June 24-29, 2007 (to be published).
- [20] M. Fadil, "About the production rates and the activation of the uranium carbide target in Spiral2", EMIS 2007, Deauville, June 24-29, 2007 (to be published).
- [21] V.N. Panteleev, G. Lhersonneau et al, "Studies of uranium carbide targets of a high density", EMIS 2007, June 24-29 2007, Deauville, France (to be published).
- [22] C. Huet-Equibec, P. Jardin et al, NIM B240 (2005) 752-761
- [23] C. Mhamed et al, Rev. of Scient. Instrum. 77, (2006) 03A702
- [24] C. Eleon et al, "The Mononake ionisation surface source", EMIS 2007, Deauville, June 24-29, 2007 (to be published), To be published in NIM-B
- [25] T. Lamy et al, "Status of charge breeding with electron cyclotron resonance ion sources", Rev. of Scient. Instrum., 11th International Conference on Ion sources (ICIS'05), France 2006
- [26] P. Royet et al, "Dossier d'Options de Sûreté SPIRAL2", Spiral2 Internal Report
- [27] P. Bertrand, F. Daudin, M. Di Giacomo, B. Ducoudret, M. Duval, "improvement of the mass separation power of a cyclotron by using the vertical selection method", Cyclotron 2004, Tokyo.