



HAL
open science

Status of the SOLEIL femtosecond X-ray source

O. Marcouillé, L. Cassinari, M.-E. Couprie, P. Hollander, C. Herbeaux, M. Labat, C. Laulhe, J. Luning, Vincent Leroux, L. Manceron, et al.

► **To cite this version:**

O. Marcouillé, L. Cassinari, M.-E. Couprie, P. Hollander, C. Herbeaux, et al.. Status of the SOLEIL femtosecond X-ray source. 34th International Free-Electron Laser Conference (FEL 2012), Aug 2012, Nara, Japan. Joint Accelerator Conferences Website, WEPD04, pp.377-380, 2012. in2p3-00749414

HAL Id: in2p3-00749414

<https://hal.in2p3.fr/in2p3-00749414>

Submitted on 4 Apr 2014

HAL is a multi-disciplinary open access archive for the deposit and dissemination of scientific research documents, whether they are published or not. The documents may come from teaching and research institutions in France or abroad, or from public or private research centers.

L'archive ouverte pluridisciplinaire **HAL**, est destinée au dépôt et à la diffusion de documents scientifiques de niveau recherche, publiés ou non, émanant des établissements d'enseignement et de recherche français ou étrangers, des laboratoires publics ou privés.

STATUS OF THE SOLEIL FEMTOSECOND X-RAY SOURCE

O. Marcouille*, L. Cassinari, M.-E. Couprie, P. Hollander, C. Herbeaux, M. Labat, C. Laulhe, J. Luning, V. Leroux, L. Manceron, J.-L. Marlats, T. Moreno, P. Morin, A. Nadji, P. Prigent, J.-B. Pruvost, S. Ravy, P. Roy, M. Silly, F. Sirotti, K. Tavakoli, D. Zerbib, J. Zhang.

Synchrotron SOLEIL, L'Orme des Merisiers, Saint-Aubin, BP 48, 91192 Gif-sur-Yvette Cedex, FRANCE.

Abstract

An electron bunch slicing setup is presently under construction on the SOLEIL storage ring for delivering 100 fs (rms) long photon pulses to two undulator-based beamlines providing soft (TEMPO) and hard X-rays (CRISTAL). Thanks to the non-zero dispersion function present in all straight sections of the storage ring, the sliced bunches can be easily separated from the core bunches. The modulator is a wiggler composed of 20 periods of 164.4 mm. It produces a magnetic field of 1.8 T at a minimum gap of 14.5 mm. To modulate the kinetic energy of the electrons in the wiggler, a Ti:Sa laser will be used, which produces 50 fs pulses at 800 nm with a repetition rate of 2.5 kHz. The laser beam is splitted into two branches in order to provide 2 mJ to the modulator and 0.5 mJ as pump pulse for the CRISTAL and TEMPO end stations. Focusing optics and beam path, from the laser hutch to the inside of the storage ring tunnel are presently under finalization. In this paper, we will report on the specificities of the SOLEIL setup, the status of its installation and the expected performances.

INTRODUCTION

SOLEIL is a third generation synchrotron radiation light source operating at 2.75 GeV. The facility produces routinely photon beams of high brightness from infrared (IR) to hard X-Rays with short pulses (20 ps FWHM) whose duration is determined by the electron bunch structure. Going down to the pico or sub-picosecond range is of great interest for studies of the dynamics of the chemical reactions, phase transitions and rapid structural changes in crystals, but is hardly achievable with the usual optics of storage ring [1]. A Slicing-based facility [2] is presently under construction at SOLEIL. The concept is based on the interaction between a short (50 fs) laser pulse operating at 800 nm and electrons oscillating in a wiggler, called "modulator". The exchange of energy between electrons and the laser pulses is driven by the analytical expression:

$$\frac{d\gamma}{dt} = \frac{-e}{m_0c} \vec{E} \cdot \vec{\beta} \quad (1)$$

Where γ , e and m_0 are respectively the relativistic factor, the charge and rest mass of the electrons, c the light celerity, \vec{E} and $\vec{\beta}$ the electric field of the laser and the normalized speed of the electrons in the modulator. Considering a planar wiggler generating a vertical

magnetic field as a modulator, the exchange differs from 0 if laser is horizontally polarized and if the fundamental wavelength λ_{RS} of the modulator equals the laser wavelength λ_L :

$$\lambda_L = \lambda_{RS} = \frac{\lambda_w}{2\gamma^2} \left[1 + \frac{K^2}{2} \right] \quad (2)$$

where λ_w is the modulator period and K the deflection parameter defined as:

$$K=0.934 B_0[T] \lambda_w[cm] \quad (3)$$

where B_0 is the peak magnetic field. The interaction between laser pulses and electrons results in a modulation in energy of the electron bunches which is converted into spatial (longitudinal) modulation inside the electron bunches. Assuming the use of a modulator generating a vertical magnetic field and a horizontal polarized laser, the maximum energy modulation $\Delta\gamma_{max}$ is given by [3]:

$$\Delta\gamma_{max} \approx \frac{2}{m_0c^2} \cdot \sqrt{5 \cdot A_L \cdot \alpha \cdot h \cdot \frac{c}{\lambda} \left\{ J_0 \left[\frac{K^2}{2} (2 + K^2) \right] - J_1 \left[\frac{K^2}{2} (2 + K^2) \right] \right\}} \quad (4)$$

where A_L is the laser pulse energy, α the fine structure constant, h the Planck constant, J_0 and J_1 the Bessel function of order 0 and 1.

Slicing was demonstrated experimentally at ALS [4] and is now used routinely at BESSY II [5], SLS [6] and ALS upgrade [7] and new setup with 2 stages of energy modulation have been proposed [8]. The slicing setup of SOLEIL presents some particularities. Firstly, several beamlines are able to use the ultra-short pulses simultaneously such as CRISTAL and TEMPO operating respectively in the 4 keV-30 keV range and 50 eV-1.5 keV range. Second, the spatial separation between the core beam and the sliced beam is performed without using any additional magnetic elements since all straight sections (SS) have a non-zero horizontal dispersion. Third, the radiation produced by the modulator will be routinely used as a source for the PUMA beam line, dedicated for the study of ancient materials [9].

This paper presents the progress of the construction of the femtosecond X-ray source: the modulator, the laser system and the diagnostics of the slicing effect.

LASER SYSTEM

The laser characteristics are presented in Table 1. The laser is already installed in the CRISTAL beamline. It serves in particular for IR pump-X ray probe experiment

* corresponding author: marcouille@synchrotron-soleil.fr

in the picosecond scale. However, a great amount of the laser power (2 mJ) is also used to generate the energy modulation inside the modulator wiggler.

Table 1: Laser Characteristics

Type	COHERENT Legend Elite DUO USP
Pulse energy at the laser exit	0.5 mJ – 6 mJ (nom.: 2.5 mJ)
Repetition rate	1 kHz – 10 kHz (nom.: 2.5 kHz)
Pulse duration	50 fs
Wavelength	800 nm

The laser is based on a Chirped Pulsed Amplification System (CPA) composed of an oscillator, a temporal stretcher, a regenerative amplifier and photon pulse compressor. The oscillator frequency is synchronized to the RF system of SOLEIL and produces short pulses of 25 fs at 800 nm with a repetition rate of 88 MHz. The laser pulses are temporally enlarged to few tens of ps in an optical stretcher to avoid excessive power during amplification. The amplification is performed in a Ti:Sa crystal pumped by a 532 nm laser operating between 1 kHz and 10 kHz. At the exit of the amplifier, an optical grating compressor enables to reach 50 fs pulse width at the exit of the laser system. To distinguish the sliced bunches from the core bunches during using experiments, a minimum spatial separation of 5 to 7 times the horizontal electron beam size is required. At SOLEIL, as the effective dispersion is high in the straight section (0.53 in CRISTAL SS, 0.19 in TEMPO SS), the energy modulation is only 14 MeV obtained with laser pulses of 0.25 mJ (equation 4). However, as the transfer losses from the laser station to the interaction area are not precisely known we consider rather an operation at nominal laser energy (#2.5 mJ).

THE MODULATOR W164

Constraints

The modulator W164 is aimed at matching the synchrotron radiation wavelength with laser wavelength (800 nm). It will be implemented in medium straight section of SOLEIL (overall length of 5.4 m). The acceptable minimum gap, usually fixed at 15.5 mm for out-vacuum devices has been relaxed to 14.5 mm due to the limited length of the modulator (3.28 m). The minimum number of periods is driven mainly by the slippage which occurs between laser pulses and electrons propagating in the modulator. Between the entrance and the exit of the modulator, the electrons are overtaken by $N_W \lambda_L$ where N_W is the period number of the modulator. If the number of periods exceeds the number of optical cycle inside the laser pulse, there is no further energy exchange. In the case of the SOLEIL laser system the minimum number of period is 19 for pulses of 50 fs. In

addition, the radiated power must remain below the technological limits of front end cooling (~20 kW), the performances of the storage ring in terms of emittance and beam life time must be preserved and the modulator should provide high photon flux up to 50 keV to satisfy the PUMA beamline specifications.

Magnetic Design

The modulator W164 is an out-vacuum hybrid wiggler composed of 20 periods of 164.4 mm. Each period consists of vanadium permendur poles surrounded with NdFeB main magnets and side magnets (see Table 2).

Table 2: Modulator W164 Characteristics

Type	Hybrid out-vacuum
Magnetic period	164.4 mm
Period number	20
Magnetic gap	14.5 mm – 240 mm
Magnetic components	Poles: VACOFLUX50 (Saturation field: 2.35 T) Magnets: VACODYM 764 TP (magnetization: 1.33T)
Max. magnetic field	1.74 T

A three period model using the RADIA code [10] and the characteristics listed in table 2 is presented in figure 1.

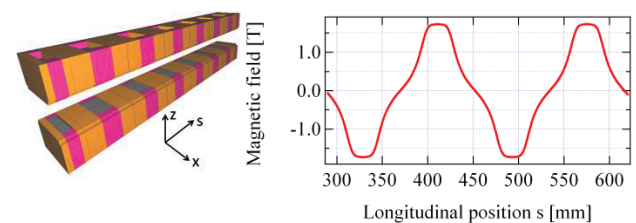

Figure 1: RADIA Short model of three periods (left) and calculated magnetic field at minimum gap (14.5 mm).

The transverse variation of the peak field and the Dynamic Field Integral (DFI) were also calculated with RADIA. The DFI results from the finite transverse width of the poles and reduces the injection efficiency and the beam lifetime [11].

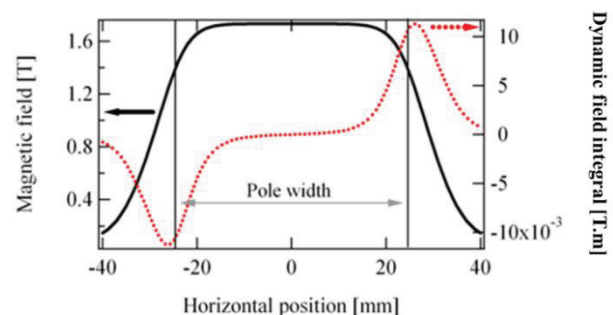

Figure 2: Transverse variation of the field (—) at minimum gap and Dynamic Field Integral (···).

To avoid any impact on the beam lifetime and the injection efficiency, it is foreseen to correct the DFI with magic finger magnets or with additional magnet blocks.

Mechanical Design

Magnets and poles are assembled on half-period supports which are mounted, once equipped on stiff stainless steel girders (Figure 3) of 3.35 m length. The gap is varied with a maximum speed of 4 mm/s from 240 mm down to 14.5 mm by two motors of SCHNEIDER BRS 39 type and is controlled by two absolute linear encoders (LTS-340) reaching a resolution of 1 μm. The modulator is set to the medium plane of the storage ring by means of four adjustable feet (+/- 10 mm).

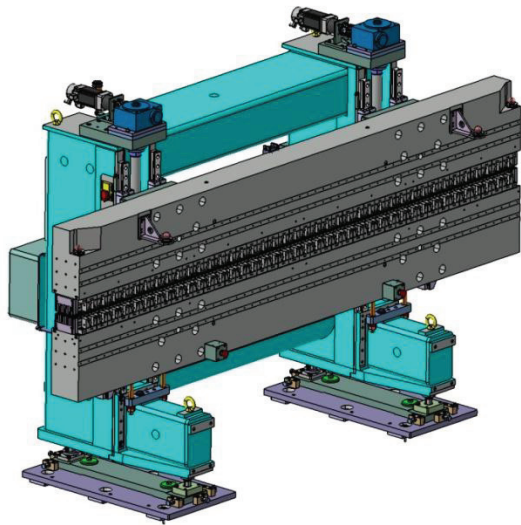

Figure 3: Carriage of the modulator (left) and half-period support equipped with magnets and poles (right).

ENERGY MODULATION

Fig. 4 shows the calculated energy modulation using the SLS code [12], GENESIS [13], ELEGANT [14] and the analytical expression (4) with the laser and modulator parameters listed in Table 1 and Table 2.

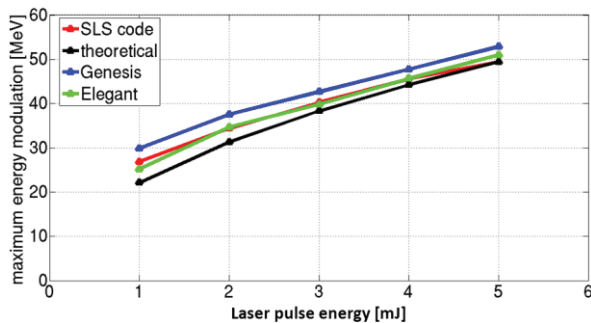

Figure 4: Maximum energy modulation calculated with the SLS code, ELEGANT, GENESIS and the analytical expression (theoretical).

The simulation using different codes are consistent with the analytical expression (4). Depending on the code, the energy modulation is comprised between 31 MeV and 37 MeV with a laser operating at 2 mJ (laser energy reaching

the interaction area), which largely exceeds the required 14 MeV. The SLS code has been also used to evaluate the longitudinal distribution of energy of the sliced electron bunch at the exit of the modulator (Figure 5). The laser and modulator parameters are respectively those listed in Table 1 and Table 2. The electron energy is periodically modulated between - 31 MeV and +31 MeV with a periodicity of 2.7 fs. Some electrons gain or lose energy resulting in a horizontal separation of the sliced electrons compared to the core electrons when they cross a non-zero dispersion section.

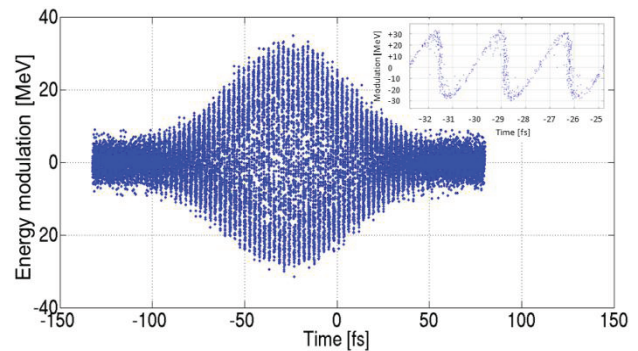

Figure 5: Energy modulation of electrons at the exit of the modulator W164.

DIAGNOSTICS

IR Diagnostic

A new diagnostic line, “IR diagnostic beam line”, is planned to be installed at the exit the modulator straight section. The laser and the modulator radiations are collected via a removable mirror to a diagnostic station composed of three devices enabling independently to measure:

- Delay between laser pulses and electron bunches. Both radiations are focused on a fast detector (IR diode from MENLO) and their delay will be adjusted via a delay line.
- Spectral overlap. The spectral matching will be insured by the tuning of the modulator gap and controlled via a spectrometer (OCEAN Optics USB 2000+).
- Spatial overlap. The photon beam emitted by the modulator will be imaged on a CCD camera (BASLER ScA 640).

Such diagnostics will be used only at low current (<10 mA) because of the excessive power emitted by the modulator at nominal current (500 mA). It will enable adjusting laser and modulator parameters in order to obtain efficient energy exchange mandatory for slicing. During usual shifts, the IR mirror will be removed to enable the PUMA beam line to be provided with X-rays photons.

THz Diagnostic

The laser will induce a local energy modulation over a few tens of fs, which will be further converted spatially into a hole via the machine optics (dispersion function). This very short structure will emit coherent radiation in the THz range. This coherent emission (CSR) will be

orders of magnitude higher than the incoherent emission in the THz range (Fig. 6) between 0.01 THz and 1 THz. A bolometer (QnBB/QMC Instruments) will be installed at the exit of the dipole beam line AILES [15]. It will enable to optimize with the THz signal intensity the first alignments already performed with the IR diagnostic station. The regular checking of the signal will also enable to verify the stability of the Slicing experiment.

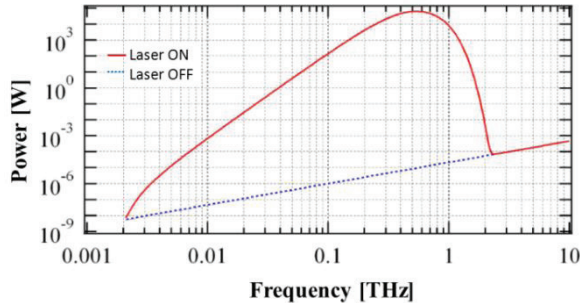

Figure 6: Calculated power radiated by the AILES dipole at 500 mA during Slicing operation (Laser ON) and user operation (Laser OFF). The energy modulation is set to 14 MeV. The laser pulse width is 50 fs.

EXPECTED PERFORMANCES

Slicing experiments are planned to be performed either with 10 mA in single electron bunch mode, with 100 mA distributed in 8 bunches or in hybrid mode (390 mA + 10 mA). Optical and temporal performances depend on all the contributing factors: laser pulse length, slippage between electron bunches and laser pulses, emittance, energy dispersion and the type of radiating section. Table 3 summarizes the different contributions in the sliced bunch length.

Table 3: Contributions in the Total Sliced Bunch Width in fs: Laser (Δt_L), Slippage (Δt_S), Emittance (Δt_E) and Energy Spread (Δt_{ES})

Radiator	Δt_L	Δt_S	Δt_E	Δt_{ES}	Total
CRISTAL	50	53	54	52	104
TEMPO	50	53	47	117	145

Due to the non-zero dispersion in the straight sections the sliced electron bunches separate naturally from the core bunches at the entrance of the radiator. The calculations of the intensity per laser pulse have been performed with the SRW code [16] in the particular case of the CRISTAL beam line operating at 7 keV (Fig. 7). The collection aperture is $0.5 \times 0.5 \text{ mm}^2$ at 15 m from the center of the radiator. The energy modulation induced by the 50 fs laser is 14 MeV (laser energy $\sim 0.25 \text{ mJ}$). The sliced bunch, even less intense than the core bunch (more than one order of magnitude) is well separated and will enable to perform preliminary experiments in the sub-picosecond range.

CONCLUSION

The specificity of the SOLEIL Slicing project results from the fact that, first, several beamlines (CRISTAL, TEMPO and later GALAXIES) will benefit from ultra-short photon pulses without any addition magnetic elements and, second, that the modulator will be used also for a dedicated beamline (PUMA). Optical equipment will be received at the end of 2012. The modulator is presently under construction and will be installed in August 2013.

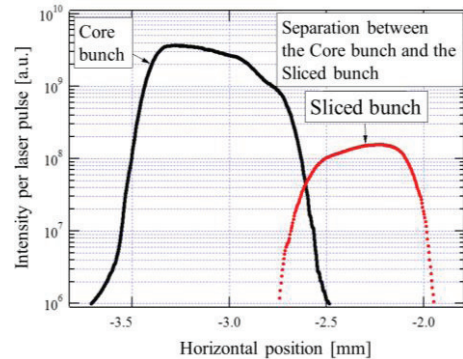

Figure 7: Intensity of the core bunches and sliced bunches in the CRISTAL versus the horizontal position.

ACKNOWLEDGMENT

The authors thank P. Beaud at SLS for providing the SLS code, M. Borland at APS for help of use of ELEGANT, Serge Bielewski for developing analytical expression helpful in the THz Range and O. Chubar for the calculation of flux. The authors thank also the ANR-DYNACO for financial support.

REFERENCES

- [1] H. Wiedemann, "Particle Accelerator Physics I and II", Springer, 1994.
- [2] A. Zholents and M. Zolotarev, Phys. Rev. Lett. 76 (1996), 912.
- [3] A. Zholents and K. Holldack, FEL2006, p. 725.
- [4] R.W.Schoenlein et al. Science 287 (2000), 2237.
- [5] S.Khan and H. A. Dürr, EPAC2002, Paris, p. 700.
- [6] G. Ingold et al, PAC2001, Chicago, p.2656.
- [7] C. Steier et al, PAC2003, Portland, p. 730.
- [8] C. Evain et al, New Journal of Physics 14 (2012), 023003 (9 pp).
- [9] PUMA website: <http://www.synchrotron-soleil.fr/Recherche/IPANEMA/methodessynchrotron#puma>.
- [10] RADIA is a collaboration ESRF/SOLEIL and is freely available for download from <http://www-sources.synchrotron-soleil.fr:8002/mid/software/>. Details have been published in: P. Elleaume, O. Chubar, J. Chavanne, Proceedings of PAC97, Vancouver, 1997.
- [11] J. Safranek et al, PRST AB, Vol. 5, 010701 (2002).
- [12] Private communication from P. Beaud (SLS).
- [13] S. Reiche, NIM A429 (1999), p. 243.
- [14] M. Borland, ANL Advanced Photon Source Report N° LS-287, 2000.
- [15] AILES website: <http://www.synchrotron-soleil.fr>
- [16] O. Chubar et al, EPAC1998, pp.1177-1179.